



Digital Video Recorder **User manual**

V5.1.19



Declaration:

Copyright ©2014

Without the written permission of the company, any company or individual should not extract, duplicate part of or all of contents of this manual and no spreading in any form.

As the upgrade of the products or other other reason, the contents of manual will be upgraded aperiodically. Unless otherwise stipulated, the manual is used as a instruction. All statements, information and suggestions of the manual does not constitute any ostensive or implied guarantee.

Product in kind prevail, final interpretations are owned by manufacturer.

Safety Precautions

Notice:

Please do not place and install equipment directly under the sunlight or near heating device.

Please do not install equipment at moist place or place with dust or soot.

Please keep equipment installed horizontally, or install equipment in a stable place, avoid the equipment falling down.

Please avoid liquid dropping on the equipment, make sure no objects filled with liquid on the equipment and prevent liquid from leaking.

Please install the device in a well ventilated place, do not block the vents of the equipment.

Please only use equipment within rated input/output.

Please do not disassembly at liberty.

Please transport, use and reserve the equipment within allowing humidity and temperature.

Warning:

Please do use the battery as requested, or it may lead to a battery fire, explosion or risk of burning!

Please use the same type of battery when changing it.

Please do use recommended cord sets(power cords), do use within the rated specifications.

Contents

Declaration:	I
Safety Precautions	II
Contents	III
1 Function and Feature	1
1.1 Outline.....	1
1.2 Function Features:.....	1
2 Appearance	1
2.1 The Front Panel.....	1
2.1.1 The Front Panel (For informational purposes only, subject to object)	1
2.2 Rear Panel.....	2
2.2.1 Rear Panel (For informational purposes only, subject to object)	2
2.3 Mouse Instructions.....	3
2.4 Remote controls.....	4
2.5 Input Method Introduction.....	4
3 Connecting DVR	6
3.1 Hard Disk Installation.....	6
3.2 Device Connection.....	7
4 DVR Startup	8
4.1 System Initialization.....	8
4.2 Boot wizard.....	8
4.2.1 Login authentication.....	9
4.2.2 Common configuration.....	9
4.2.3 Network configuration.....	9
4.2.4 Record Setup.....	10
4.3 Preview Interface.....	11
5 DVR Menu	12
5.1 Menu Options.....	12
5.1.1 Volume Settings.....	13
5.2 Main Menu Navigation.....	13
5.3 Main Menu.....	14
5.3.1 Record Query.....	14
5.3.2 System Information.....	17
5.3.2.1 Log Information.....	18
5.3.2.2 Version Information.....	19
5.3.3 System Setup.....	19
5.3.3.1 Common Set.....	20
5.3.3.2 Encoding parameters.....	21
5.3.3.3 Rec Setup.....	22
5.3.3.4 Network.....	23
5.3.3.5 Video Detection.....	25
5.3.3.6 PTZ Setup.....	26
5.3.3.7 Display.....	28
5.3.3.8 Restore Default.....	29
5.3.3.9 Image Color.....	30
5.3.3.10 P2P configuration.....	31
5.3.3.11 DDNS.....	31
5.3.5 Advance Option.....	32

5.3.5.1 Disk.....	32
5.3.5.2 User.....	33
5.3.5.3 Upgrade.....	34
5.3.5.4 Live Setup.....	35
5.3.5.5 Auto Maintain.....	36
5.3.6 Shut Down.....	37
6 WEB Operation.....	38
6.1 Active X install.....	38
6.2 Accessing by Web Browsers.....	39
6.3 Live Video.....	39
6.3.1 View Images.....	39
6.3.2 PTZ.....	40
6.4 Playback.....	41
6.5 IE Log search.....	41
6.6 Config.....	42
6.6.1 Local Configuration.....	42
6.6.2 System.....	43
6.6.2.1 Common.....	43
6.6.2.2 Encode.....	44
6.6.2.3 Rec Setup.....	44
6.6.2.4 Network.....	45
6.6.2.5 Motion Detection.....	46
6.6.2.6 Default.....	46
6.6.2.7 DDNS Setup.....	47
6.6.2.8 SMTP Setup.....	47
6.6.2.9 P2P Setup.....	48
6.6.3 Advance Setup.....	48
6.6.3.1 Disk.....	48
6.6.3.2 User.....	49
6.6.3.3 System Upgrade.....	49
6.6.3.4 Auto Maintenance.....	49
6.6.4 System.....	50
6.6.4.1 Version.....	50
6.7 Logout.....	50
7 Appendix.....	51
7.1 Q&A.....	51
7.2 Maintenance.....	52

1 Function and Feature

1.1 Outline

The item is a high-performance DigitalDVR, characterizing local previewing, multi-picture division displaying & local real-time storage of recorded files. It supports shortcut operating of mouse and remote managing and controlling. It has two ways of storage--Front storage & client-side storage. This product is a high-performance digital disk recorder. It has the functions of local preview,multi-split screen displays and local real video file storage capabilities.If also supports for mouse shortcuts,and has remote management and control functions.The product supports both the client front-end storage and client storage.This series DVR can not only be used independently,but also be networked to form a powerful Digitalmonitoring center.It has been widely used in domestic and foreign banks, telecom,power,justice,transport,community,factories,warehouses resources, water conservancy facilities etc. Areas and departments security.In addition,it also plays an important role in home security monitoring system.

1.2 Function Features:

- H.264 video condense format, Support 960H/AHD Analog input.
- G.711U audio condense format.
- Windows-style user interface, embedded real-time Linux3.0 operating system.
- Support preview, recording, play back, backup.
- Supports dual stream.
- USB2.0, support backup, software upgrading & mouse operating.
- Support for multiple languages.

Function	Function Brief Introduction
Real-time	Two video output, VGA & HDMI output.
Record	H.264 standard compression, timing recording.
Storage	Support SATA Hard Disk interface, video hard drive storage .
Record Query	Support time query, event query, channel query, log query
Backup	Support DVR backup to USB memory sticks, portable hard drive or a Digitalbackup to hard drive.
DigitalOperating	Support for remote client access, improve system safety.
Mouse Operating	Support USB mouse operating, easily and quickly set system parameters.
PTZ Setup	Support PTZ presets point、 automatic cruise.
Pan-tilt Control	By analyzing video images, when the system detects a mobile signal reaches a preset sensitivity occurs, motion detection alarm is initiated and the linkage function.



2 Appearance

2.1 The Front Panel

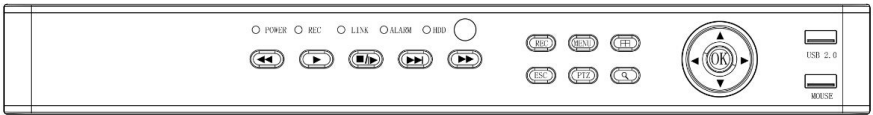
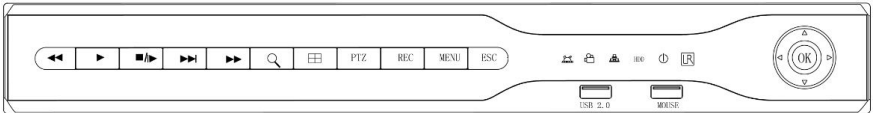
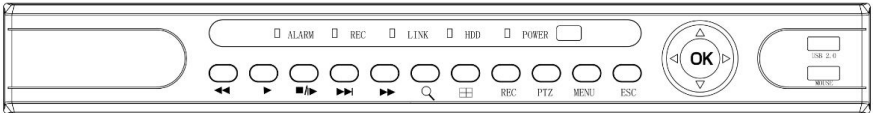
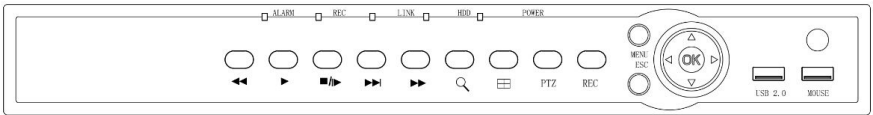
2.1.1 The Front Panel (For informational purposes only, subject to object)



NO	Button or indicator light	Main Functions
1	LED Indicators	When working properly, the LED indicator lights up
2	◀ Playback	Increase reverse playback speed 1X, 2X, 4X, 8X
3	▶ Play	Press to start playback
4	■▶ Pause/Frame	Press to freeze playback to one frame, then press again to advance frame-by-frame
5	▶▶ Slow play	Press to slow playback speed by 1/2, 1/4, 1/8
6	▶▶ Fast play	Press to increase forward playback speed 1X, 2X, 4X, 8X

7	 E-ZOOM	When working properly, the LED indicator lights up.
8	 windows	Press to switch between quad and split-screen displays
9	PTZ	Press to open the PTZ control window
10	REC	Press to open the PTZ control window
11	MENU	Opens the main menu
12	ESC	Opens the main menu
13	 Navigation/OK	Move cursor in menus;press to confirm selections

2.2 Rear Panel

2.2.1 Rear Panel (For informational purposes only, subject to object)

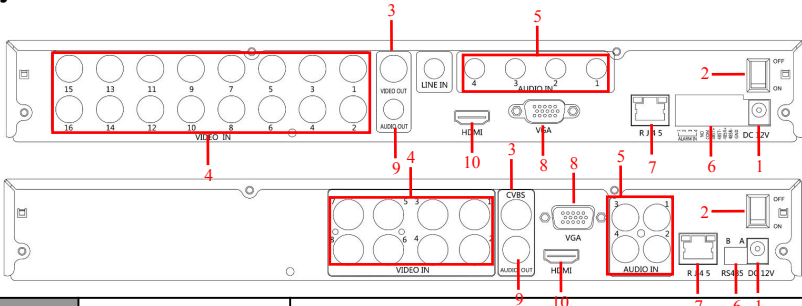

No.	Interface	Connection instruction
1	Power input	DC12V/5A
2	ON/OFF	ON/OFF
3	Video output	Output by TV/BNC
4	Input	BNC
5	audio input	audio input
6	alarm input	4 /I alarm input
	alarm output	I/O output for alarm
7	RS 485	RS 485 for connecting PTZ
7	Network	For connecting Ethernet
8	VGA	For connecting VGA monitor
9	Audio output	For connection audio output
10	HDMI	For connecting HDMI monitor

2.3 Mouse Instructions

Mouse instruction

Operate DVR through mouse left button, right button & scroll wheel.

Mouse actions	Function
Click left mouse button	1. Select one of the options; 2. insertion cursor, enter or modify the value of a parameter.
Click right mouse button	1. When interface not locking , click right mouse button, system menu pops up; 2. When interface locking, click right button on real-time preview interface, login interface pop up ; 3. Entered to main menu, to a submenu of PTZ control, click right mouse button on the menu interface, return to previous menu (except video playback interface); 4. Entered to close system interface, click mouse right button on the interface, return to preview interface.
Double-click the mouse left button	1. When real-time preview multiple channels interface, double-click maximized channel display of one channel and return to the original state; 2. Double click the password input field on the login interface; 3. setting parameters (date, time, IP address, port number, bit stream value and user password) or user names
mouse movements	Select the menu or menu item.
Mouse drag	Drag progress bar to playback video.
Slide mouse scroll wheel	1.Time setting; 2.Select the drop-down menu values;

2.4 Remote controls

The remote control is the secondary input device.

To use the remote control:

1. STANDBY: Press to turn standby mode ON/OFF.

2. LOGIN/LOCK: If "Security" has been enabled in the Setup menu, press to open the user password login screen.

3. Number/Channel buttons: While in menus, press buttons 0~9 to enter values; during live viewing, press to view channels in full-screen.

4. Multiple-window switch: Press to switch between Single and split-screen displays.

5. PTZ: Press to open the PTZ control

Interface.

6. MENU: Opens the main menu.

7. EXIT: Close menu windows.

8. Navigation/Enter:

- ▲: Move cursor in menus up;
- ►: Move cursor in menus right;
- ◀: Move cursor in menus left;
- ▼: Move cursor in menus down;

9. +/- : In menus, press to adjust values.

10. Playback controls :

- ►: Press to start playback.
- ►►: Press to increase forward playback speed 2X, 4X, 8X.
- ►►►: Press to slow playback speed by 1/2, 1/4, 1/8.
- ◀◀: Increase reverse playback speed 2X, 4X, 8X.
- ■: Pause or frame by frame playback picture; press for the first time to pause playback image; then continue continuous press, a second one frame every player;

11. STOP: Press to stop playback .

12. RECORD: Press to start manual recording, then press again to stop manual recording.

13. MUTE: Close live audio output.

14. AUDIO: Enter the volume control interface.

15. EXTRA: For the future use.

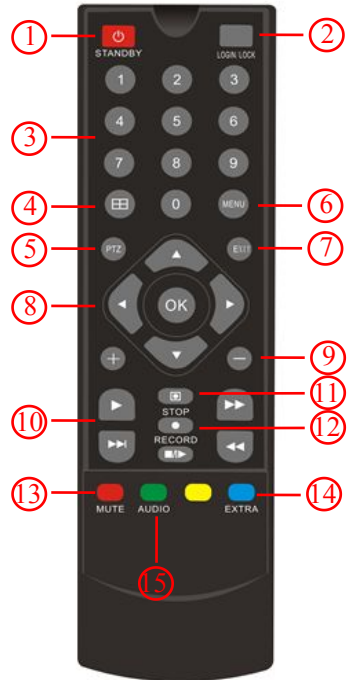

2.5 Input Method Introduction

Input method includes lowercase and uppercase English letters. Clicking the Shift button on the left can switch the input method and the symbol "←" represents deleting incorrect input.



Uppercase English input



Lowercase English input

3 Connecting DVR

3.1 Hard Disk Installation

Hard Disk Installation:

(1) Loosen the fixing screw on the cover, open the cover.

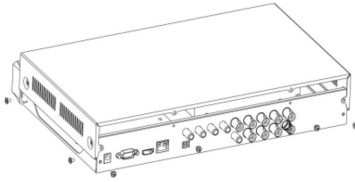

(2) Align the four holes of hard disk button with hard disk mounting hole at the button of chassis.

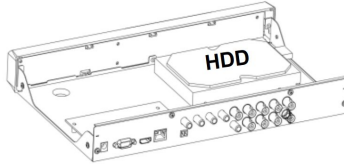

(3) Hold the hard disk with hand, turn over the chassis, fix the hard disk with screw at the indicated position.

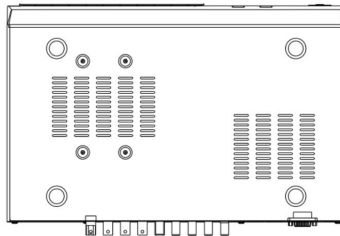

(4) After hard disk installed, turn over the chassis, fix the cover with screw.

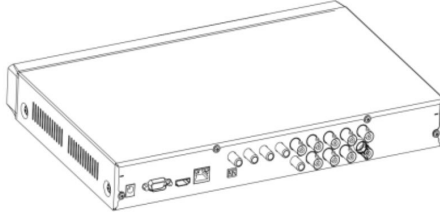

Note: 1. If user requires high performance of hard disk, we recommend the dedicated security hard disk.

2. Before replacing the hard disk, please shut off the power first and then open the case.

3.2 Device Connection

Show the DVR signal on the monitor by VGA / BNC / HDMI cable. If the camera possible PTZ control, contacting the PTZ RS485 cable A and cable B contact with the DVR RS485.

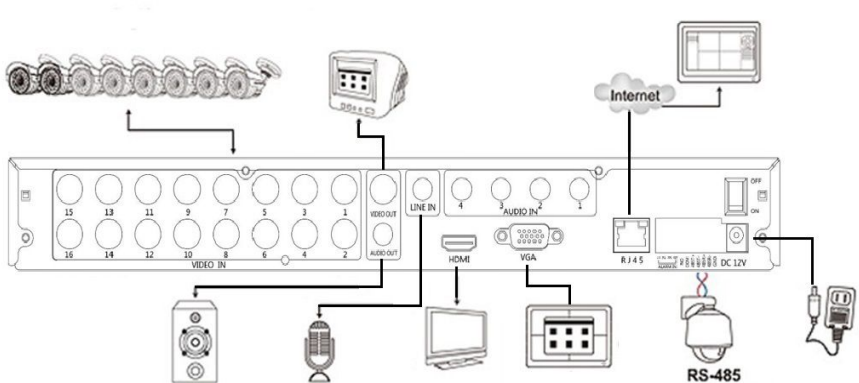

4 DVR Startup

4.1 System Initialization

After connecting the device to the display, plug in the mouse, power cable and turn on the power switch on the rear panel, then start up the DVR. The system initialization interface is as shown in Figure 4-1.



Figure 4-1

Notes: The insert figures in this user manual may not be the same as what you see on display. All figures here are just for reference.

4.2 Boot wizard

After the device startup is complete, load the "Wizard" screen, as shown in Figure 4-2, you can make a simple configuration via the boot wizard, you can make the device into the normal working condition.

After the normal startup, if you not choice the checkbox it will not appear next time. User find it at normal setting menu, or setting it after factory default.

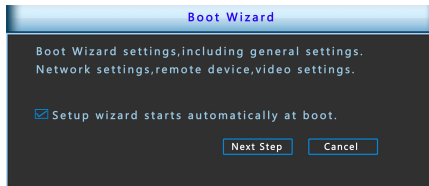

Figure 4-2

4.2.1 Login authentication

After the normal startup, click mouse button and there will be a login dialogue, as shown in Figure 4-3 Then enters the user name and password in the input box. Choose the system language and login. (In the factory default state, the user name is admin, and the password is 12345)

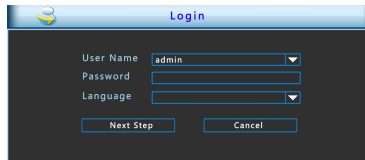

Figure 4-3

4.2.2 Common configuration

Click “Basic configuration” ,as shown in Figure 4-4, In this interface user can setup the device name, device ID, video format , Video Output and language, Screen saver and so on. Then enter the Digitalset or cancel exit the boot wizard.

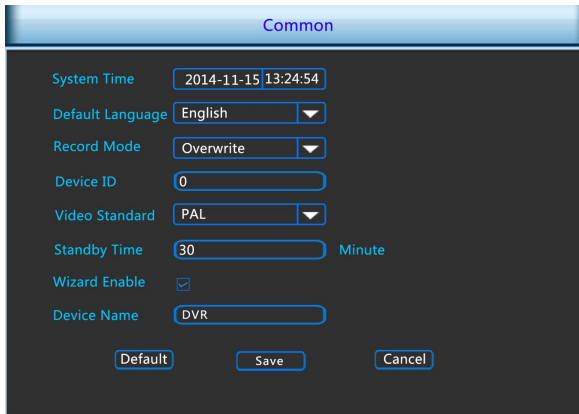

Figure 4-4

4.2.3 Network configuration

Network configuration as Figure 4-5. Choice step back to general setting interface. Network configuration includes : network(IP address, gateway setting), other functions as below 5.3.3.1. Do next step enter the Video configuration, if you do not need to Network configuration.

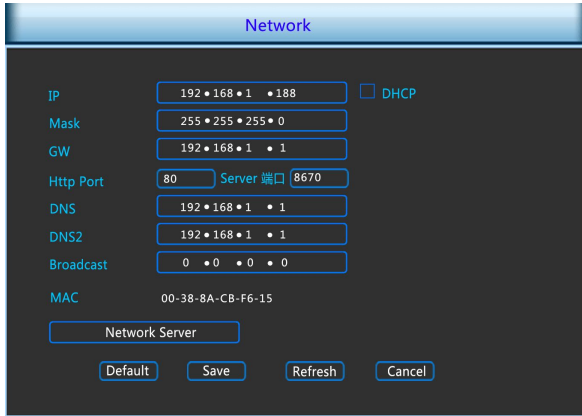

Figure 4-5

4.2.4 Record Setup

Digital configuration as Figure 4-6, select back on the Digital setting interface, user can set the video program, all settings as Figure 5.3.3.4. If you do not need to video configuration, choose to complete end of boot wizard, enter the preview interface.

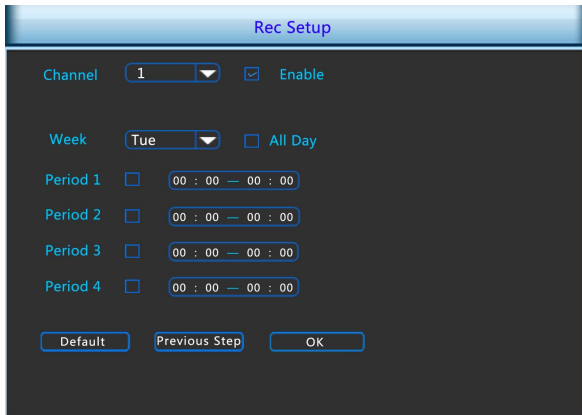

Figure 4-6



4.3 Preview Interface

After the system is fully booted, it will enter into the default preview interface, shown in Figure 4-7.



Figure 4-7

After the device normally starts up, the default setting is to preview in multi-screen display mode. Products with different channels has different amount of split screens to display. On the preview interface, you can set the appropriate date and time. On the bottom left of the screen, it shows the recording status of each video channel or alarm status icon.

- : this icon means monitoring channel is recording;
- : this icon means monitoring channel is in motion detection.

5 DVR Menu

5.1 Menu Options

After login the system and back on the preview interface, click the right mouse button and it will pop up the Menu Options, shown in Figure 5-1. Then you can select options of the Main Menu, Volume Settings, the Main Screen Switching, Playback, PTZ Control and System Shutdown. In addition, you can set the channel display as follows: single-screen display, four-screen display, eight-screen display, night-screen display. It needs to set a specific number of channels to achieve single-screen display, four-screen display, etc.. The corresponding operation of the Main Menu Options will be illustrated in details in later chapters.

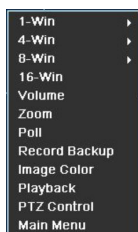

Figure 5-1

- **Single-screen Display:** Select one channel to display from CH1~CH16 .
- **Four-screen Display:** Divided into four groups to display (CH1~CH4、CH5~CH8、CH9 ~CH12、CH13~CH16).
- **Eight-screen Display:** Divided into two groups to display (CH1~CH8、CH9 ~CH16).
- **Sixteen-screen Display:** Display all channels CH1 ~CH16.
- **Volume:** Click to enter the volume setting interface, See chapter 5.1.1.
- **Zoom:** Choose Digital zoom function in the channel you want and drag the left mouse button to choose one area on this channel. When you release the left button, the chosen area will be digitally zoomed. Drag in any direction is supported.
- **Poll:** Enter Tour Settings Interface. When there are several dissociative windows, you can set single or multipal windows to tour different groups simultaneously.
- **Record Backup:** Enter Video backup Interface and insert the USB Disk. Then choose the channel and date that you want to back up the videos.
- **Image Color:** Click into the image color configuration interface. See chapter 5.3.3.9.

- **Playback:** Click into the Playback interface, See chapter 5.3.1.
- **PTZ Setup:** Click to enter PTZ control configuration menu, See chapter 5.3.3.6.
- **Main Menu:** Click and enter the main menu, See chapter 5.3.

5.1.1 Volume Settings

Click right month button on the preview screen, select the volume option on the shortcut menu, enter the volume setting menu, shown in Figure 5-2.

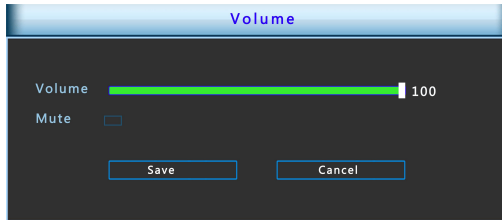
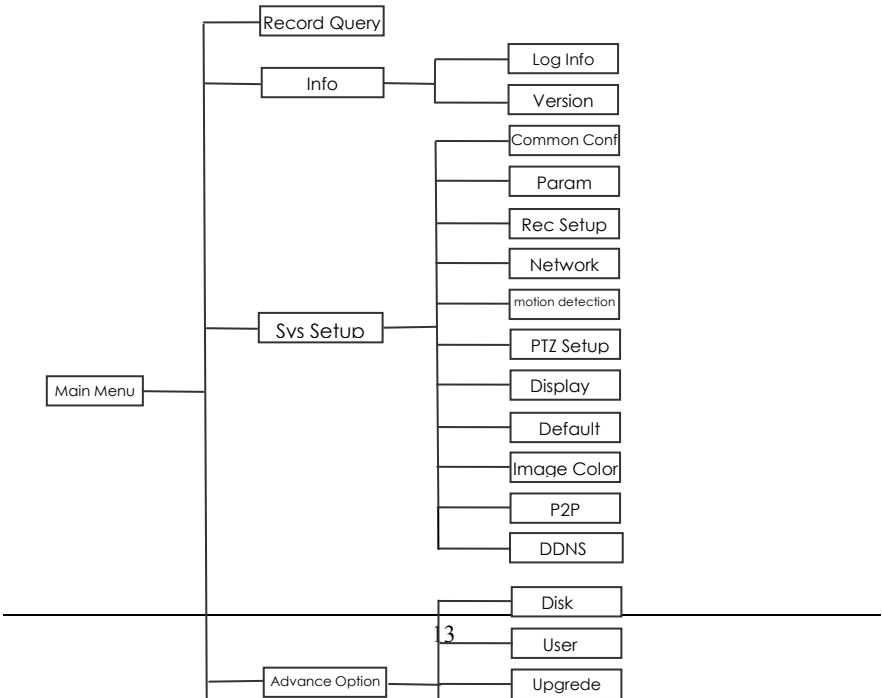

Figure 5-2

- **Mute:** ON/OFF volume.
- **Volume:** Volume adjustment bar, drag the slider to adjust the volume.
- **Save:** Save the volume settings.
- **Cancel:** Back preview interface.

5.2 Main Menu Navigation



5.3 Main Menu

Main Menu includes Record Query, System Info, System Setup, Advance Option, Shutdown five parts, as shown in Figure 5-3. Select one and click the left mouse button to open the corresponding next menu options.

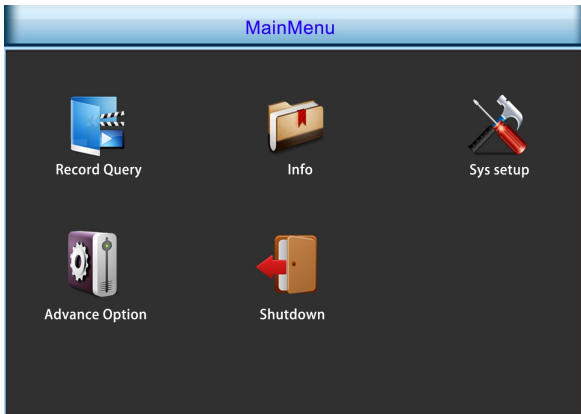

Figure 5-3

5.3.1 Record Query

After entering the main menu, open the "Record Query" menu or right-click to choose select "right-click" menu in the preview interface, switch to video query interface, shown in Figure 5-4.

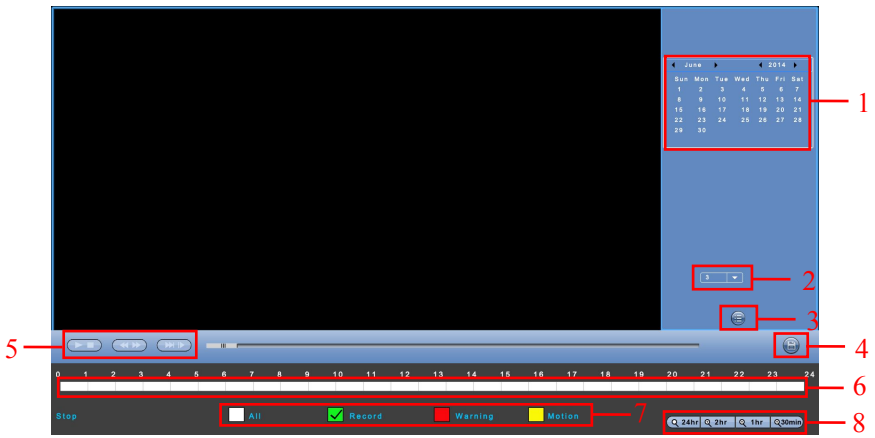

Figure 5-4

No.	Name	Function Specification
1	Calendar	In any play mode, select the recording type and channel number, click on the date you want to view, the timeline will update the recorded video for that day.
2	Choose the Playback Channel	Select the channel number to query.
3	File List transfer button	Select the date, channel number and record type, click into the video file list. Select the desired video file, double-click the left mouse button to start playing the video file.
4	Backup	Backup video file, the default format to avi
5	Playback Control Area	On the playback control bar, you can normally play, pause, fast forward, fast forward playback mode, you can select 1x, 2x, 4x, 8x, 16x, 1x which is played at normal speed;
6	Timeline	Query to the video file, updated for the day that recording tracks on the timeline. Under the four-frame playback mode, display the selected four channels corresponding to four playback timeline, other playback mode displays only one playback timeline. Click on the green area to start from that point of time for playback.
7	Select video type	Select the type of video, you can choose the type for all types of video, timed recording, alarm recording and detection recording.
8	Timeline unit selection	Including 24h, 2h, 1h and 30min, the smaller units of time the greater the proportion of time zoom, you can adjust the exact point in time to play back video on the timeline. If the page is in the configuration, the timeline is 0:00 start amplification; if the page is being played, the places within the scope of the current playing time recently enlarged.

In the file list bar, you can see the start time of the video file, video type, select a video file, you can view the video of recording start time, end time and file size, as shown in Figure 5-5.

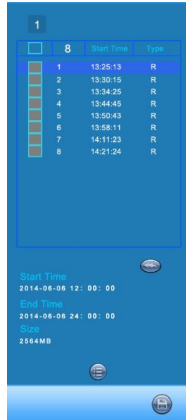



Figure 5-5

In the file list box, click to choose the video file selection box , showed icon "√", click this icon  to backup the video files (external U disk), the files are "avi" format. You could also click to choose multiple video files selection box to backup those video files, users can also cancel this icon "√" in the backup operation menu in the file list box, delete those video files that unwanted.

5.3.2 System Information

Left-click the icon of "Info" in the main menu, shown as Figure 5-6 below, including "Log info" and "Version" of two sub-menus.

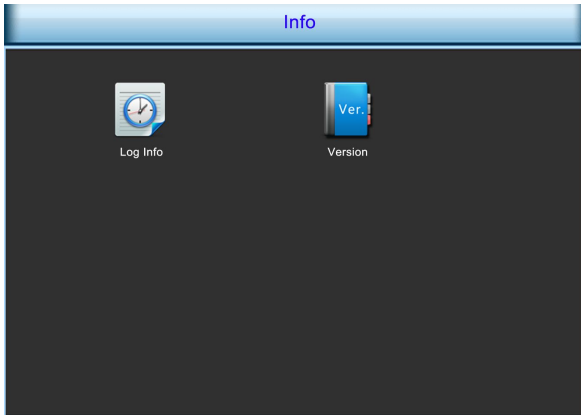

Figure 5-6

5.3.2.1 Log Information

Under the "Info" menu, please click "Log Info", and then switch to the interface of "Log Info". As shown in Figure 5-7.

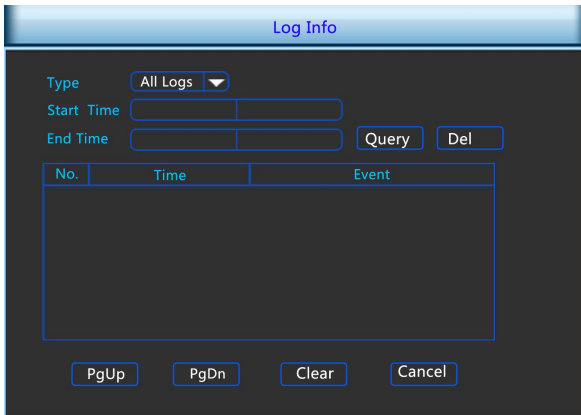

Figure 5-7

Viewing System Logs to access the logs and search for these events on one day a certain period of time.

- **Type:** Select the type of information you request.
- **Start Time/End Time:** Enter the time to find the logs.
- **Search:** Search for logs according to criteria.
- **PgUp/PgDn:** You can view all logs through the PgUp/PgDn.
- **Clear:** Clear all information.
- **Cancel:** Return to the former menu.

Specific Steps: Enter the log search menu, set search parameters, click the Search button to begin search, If logs matching the search criteria are

found, it will be displayed in a list, To view all logs through PgUp/PgDn button.

5.3.2.2 Version Information

Click "Version" icon under "Info", switch to interface as Figure 5-8 shows.

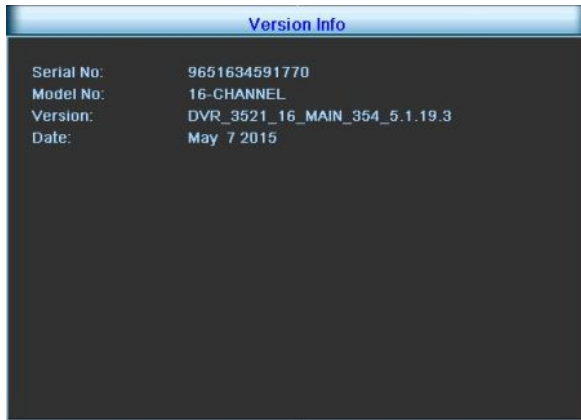

Figure 5-8

Users can find system version, including serial No, model number, system version,Version Date.

- **Serial No.:** Showing the serial No.of the DVR.
- **Model number:** Number of main board.
- **Version:** System version number.
- **Date:** Program created date.

5.3.3 System Setup

Left-click the icon of "Sys Setup" in the main menu, shown as Figure 5-9 shows.



Figure 5-9

5.3.3.1 Common Set

Click "Common Config" icon under "Sys Setup", switch to interface as Figure 5-10 shows.

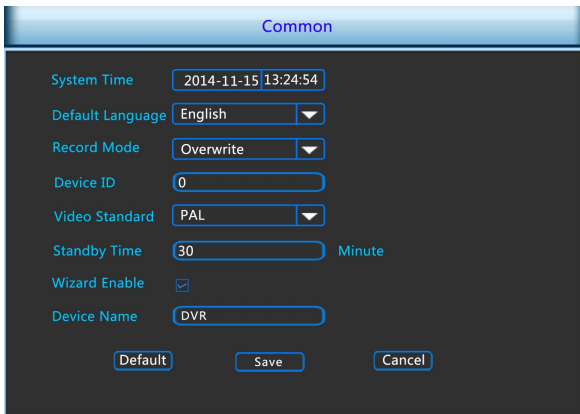

Figure 5-10

- **System Time** : System date and time of DVR.
- **Default Language** : the default language of the system boot, which is English, but, at present, also supports Chinese, Polish, Czech, Russian, Thai language, Hebrew, Persian, Bulgarian, Arabic, German, French, Portuguese, Turkish, Spanish, Italian, and Hungarian.
- **Record Mode** : Overwrite automatically, ie., DVR will automatically cover the previous record if hard disk is full.
- **Device ID** : Reserved.
- **Video Standard** : PAL or NTSC.

- **Standby Time:** It means standby time of system without operation for DVR. If time exceeds the standby time, then you should re-login in system so as to operate DVR. Default standby time is 30 minutes. And standby time range is: 1 to 120 minutes.
- **Open the wizard:** means boot the wizard function.
- **Device name:** Set the name of the device.
- **Default :** Restore all specifications or parameters of common setup to be factory default specifications.
- **Save:** To save specifications or parameters of common setup.
- **Cancel :** Return to the former interface.

5.3.3.2 Encoding parameters

Click "Param" icon under "Sys Setup", switch to interface as Figure 5-11 shows. Resolution, Frame Rate, Stream Type, Bit Rate, Sub-stream can be set under "Param" Interface.

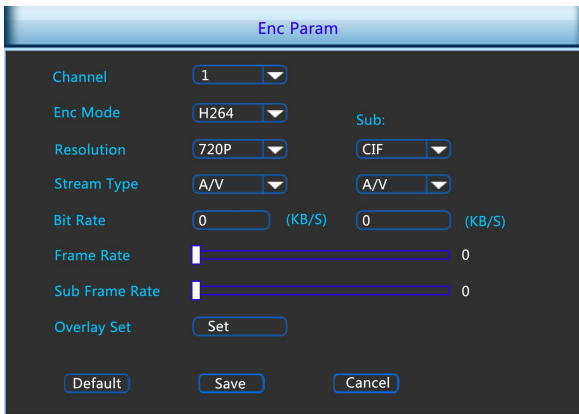

Figure 5-11

- **Channel:** Select the channel number
- **Enc Mode:** Standard H.264.
- **Resolution:** The type of main stream resolution is the encoding parameters of client IPC, generally include D1/720P/1080P etc, the type of sub-stream resolution include D1/VGA/CIF. The resolution is bigger, the better the video quality, and the larger the hard-dish space occupied. On the contrary, the resolution is smaller, the worse the video quality, the smaller the hard-ship space occupied.
- **Frame Rate:** P type: 1 frames / sec-25 frames / sec; N type: 1frames / sec-30frames / sec.
- **Stream type:** Select video stream or audio stream..
- **Bit Rate:** Setting bit rate can change the picture quality, the larger the bit rate and the better the picture quality.

- **main stream/subcode flow frame rate:** User according to the demand to select encoding video frame rate.general the image quality, frame rate and resolution parameters setting higher, the more take up disk space.

Notice: code flow resolution and frame rate is restricted by different type device and program vision.

- **Default:** Recover all the encoding parameter to default values.
- **Save:** Save the parameters on preview configuration menu.
- **Cancel:** Return to the former interface.

Overlay Set

Override the settings interface, as shown in Figure 5-12. Cover Set,Time title, and Channel title can be set under "Overlay Set" Interface.



图 5-12

- **Block set:** Set the channel preview and playback occlude areas.
- **Time tile:** Set the playback channels display position.
- **Channel title:** Set the playback channels system time display position.
- **Save:** Save preview configuration interface setting parameter values.
- **Cancel:** Return the management interface.

5.3.3.3 Rec Setup

Click "Rec Setup" icon under "Sys Setup", switch to interface as Figure 5-13 shows.

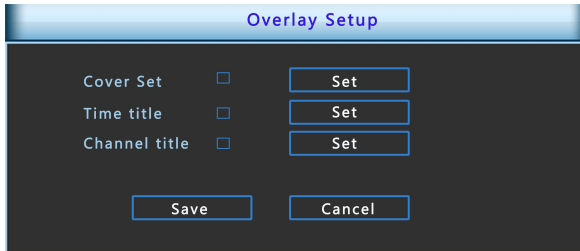
Figure 5-13

- **Channel:** Select a channel to record. There are 2 choices: single channel and all channel. A specific channel should be chosen for choice of single channel.
- **Enable:** Make enable is open. start video.
- **Week:** Choice the one day or each day start video during one week.
- **All Day:** Record the whole day. whole day video.
- **Period:** If not all day record, then any four periods can be set to record during the periods.
- **Default:** Restore parameters of record setup to be default ones.
- **Save:** Save parameters of current interface.
- **Cancel:** Return to the former interface.

5.3.3.4 Network

Click "Network" icon under "Sys Setup", switch to interface as Figure 5-14 shows.

Figure 5-14

- **DHCP:** after selecting the option, set the access mode of the local IP address to be automatic access, or you should manually set up the IP address.
- **IP Address:** IP address of DVR.
- **Subnet Mask:** Subnet mask of DVR.
- **Default Gateway:** Default gateway of DVR.
- **TCP Port:** Reserved.
- **RTSP Port:** RTSP data port of DVR.
- **HTTP Port:** Port for visit by IE browser for DVR.
- **Primary DNS:** It is usually offered by local ISP. Your IP address of domain name server is entered here.
- **Secondary DNS:** Start secondary DNS when the primary one does not work.
- **Broadcast:** Reserved.
- **MAC Address:** MAC address of DVR.
- **Default:** Restore all parameters of Digitalsetup to be defaulted ones.
- **Save:** Save parameters of common setup interface.
- **Refresh:** clicking Save to save the parameters to the device after finishing all the parameters setup and click Refresh to acquire the latest configuration information of the device.
- **Cancel:** Cancel the set Digitalof current interface.

DigitalService

Click the Digitalservices, enter Digitalsettings service interface. Can send you email when alarm occurs,pic 5-15. Open UPNP, all the PC show DVR icon at Digitalplaces, click two times and login with password to view.

Notice: Router must support and open Upnp function when you use it, shown in Figure 5-15.

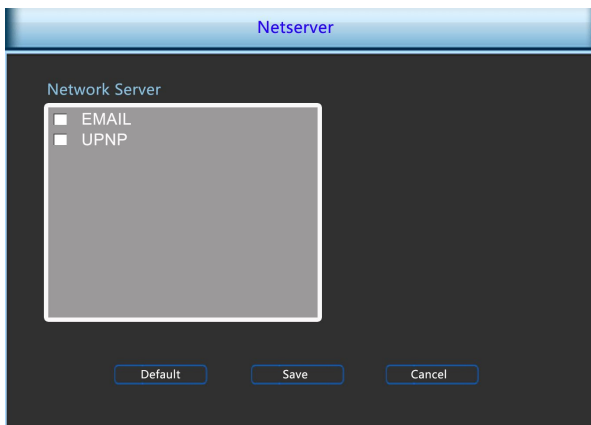

Figure 5-15

Double-click the mail settings at the Digitalservice, enter the mail setting interface. Can send you email when alarm occurs, shown in Figure 5-16.

Figure 5-16

- **SMTP server:** The address of the mail server, which can be an IP address and a domain name (domain name needs the confirmation of the correct DNS setup to be resolved correctly).
- **Port:** Port number of the mail server.
- **User name:** User name of the sender's mail.
- **Password:** Password of the corresponding user name.
- **Receiver:** The warning information can be sent to the designated receiver via mail, three recipients can be set up.
- **Sender:** Setting the EMAIL address of the mail sender.
- **Interval:** Interval for sending the alarm mail.
- **Default:** Setting all the parameters in the Email Setup interface to be default.
- **Save:** Saving the parameters in the Email Setup interface.
- **Return:** Going back to the former management interface.

5.3.3.5 Video Detection

Click "Motion Detect" icon under "Sys Setup", switch to interface as Figure 5-16 shows. When the system detects a mobile signal reaches a preset sensitivity occurs, motion detection alarm and the linkage function will be initiated by analyzing the video image.

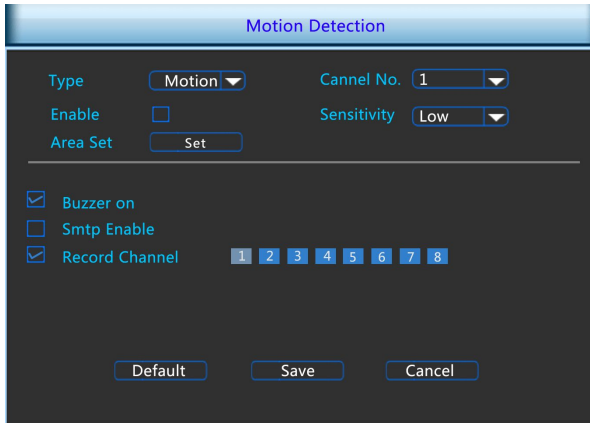

Figure 5-17

- **Type:** video detection including motion detect alarm and Video loss alarm.
- **Channel No:** Select the motion detection channel. 2 option: Single and All), for the Single channel, you need to choose the particular channel.
- **ON/OFF:** open video detection function.
- **Sensitivity:** 7 values can be set for the sensitivity.
- **System locale:** Set the trigger video detection area.
- **Buzzer on :** Open Buzzer
- **Smtp Enable:** open mail alarm, system send mail when alarm occurs, for example, alarm event, capture Figure, device name and device ID.
- **Record channels:** open the trigger video, choice the video channel, system alarm channel when alarm occurs.
- **Default:** Recover all the alarm setting parameters to the default values.
- **Save:** Save the set parameters of current menu.
- **Cancel:** Don't save the set parameters of current menu.

5.3.3.6 PTZ Setup

In the preview screen, select a channel preview window, click the right mouse button and click PTZ control options, the preview screen will switch to the single-channel display, and PTZ control interface appears in the lower left corner, as shown in Figure 5-18

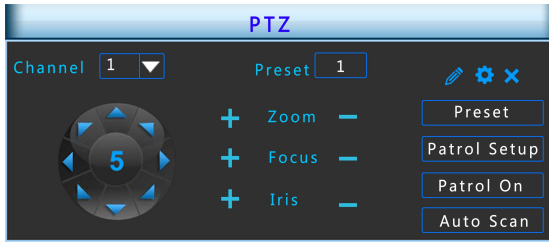
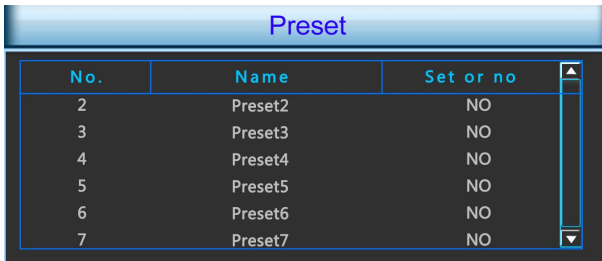

Figure 5-18

Adjusts the movement speed of the PTZ, (click middle button of the wheel to set speed) Directional Buttons controls the movements and directions of the PTZ. zoom, focus, iris can be adjust by increase "+", reducing the "-" button.

- **Presets position:** Can select certain Presets to Configure Preset or Call Preset, Clear Preset, range from 1 - 255.
- **Presets point:** The presets box choose a certain preset point need go to, After click on the switch icon, PTZ will jump to that location. Click the Presets button, like pop-up screen shown in Figure 5-19, you can view the setting status of presets from 1-255;



No.	Name	Set or no
2	Preset2	NO
3	Preset3	NO
4	Preset4	NO
5	Preset5	NO
6	Preset6	NO
7	Preset7	NO

Figure 5-19

- **Cruise Settings:** Set the function of cruise, and related presets setting of cruise, including dwelling time and cruising speed. Shown in Figure 5-20 and Figure 5-21;

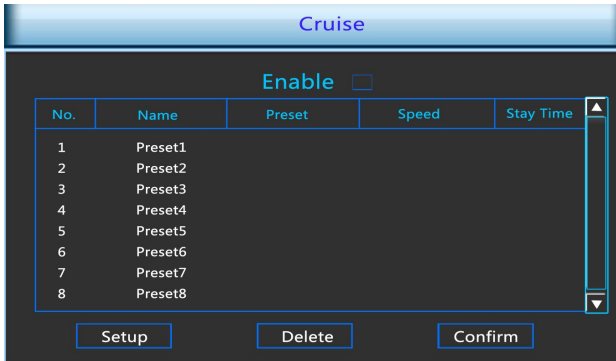

Figure 5-20

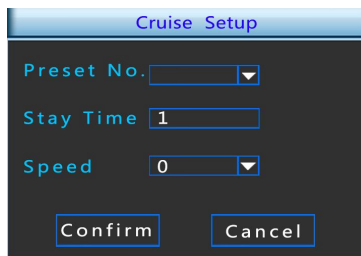

Figure 5-20

- **Stay Time:** Stay time on the Preset.
- **Cruise speed:** Speed for Cruise.
- **Start Cruise:** Start Cruise, and patrol in fixed path.
- **Auto Scan:** Clear all preset point.

Notice: the DVR supports maximum 255 preset point, however, it is also affected by the PTZ Camera itself, for different PTZ Camera, the number of preset point supported could vary a lot.

5.3.3.7 Display

Click "Display" icon under "Sys Setup", pop up the display configuration interface, could modify the display resolution and channel names, shown in Figure 5-22.

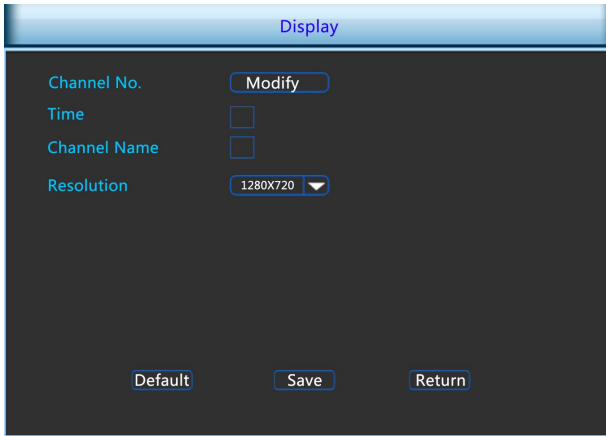

Figure 5-22

- **Time Title/channel title:** After the selected can display system time/channel name.
- **Channel Name:** Click on the name of the channel can be modified to display the name of each channel, as shown in Figure 5-23.
- **Resolution:** It means the resolution of video output of DVR. Optional resolution: 1024×768 、 1280×720 、 1280×1024 、 1920×1080. Default resolution is 1280×720. It will be valid only after DVR is re-started with all specifications saved.



Figure 5-23

5.3.3.8 Restore Default

Click "Default" icon under "Sys Setup", transfer to the interface of default, as shown in Figure 5-24.

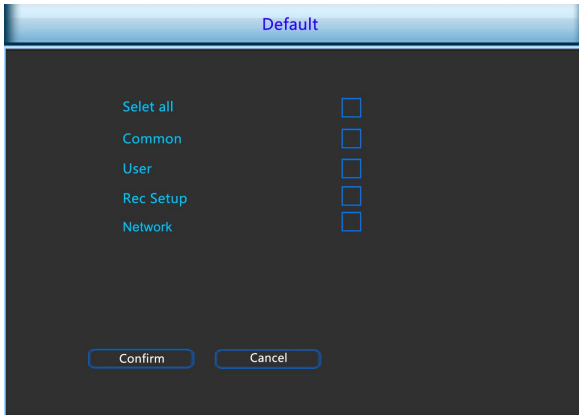

Figure 5-24

According to user selection, you can set the parameters of restore default for “Common”, “User”, “Record Setup” and “NetWork”.

5.3.3.9 Image Color

Click “Image Color” icon under “Sys Setup”, pop up the video configuration menu, then can configure the video properties of IPC. As shown in Figure 5-25.

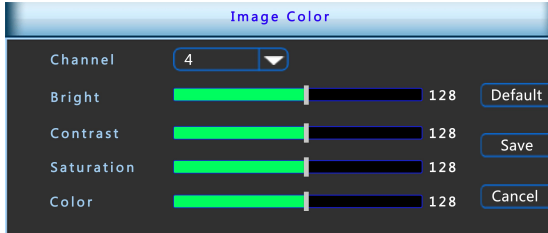

Figure 5-25

- **Channel:** Select the Channel number.
- **Bright:** Bright adjustment.
- **Contrast:** Contrast adjustment.
- **Saturation:** Saturation adjustment.
- **Color:** Color adjustment.
- **Default:** Recover all the video configuration parameters to default value.
- **Save:** Save configured parameters value on video configuration menu.
- **Return:** Return to last management menu.

5.3.3.10 P2P configuration

Double click left mouse P2P configuration, enter P2P setting interface, shown in Figure 5-26. P2P including mobile client remote monitoring, can be add mobile client by scanning the QR code.



Figure 5-26

5.3.3.11 DDNS

Double click left mouse DDNS configuration, enter DDNS setting interface, shown in Figure 5-27., can be set up remote through the domain name.

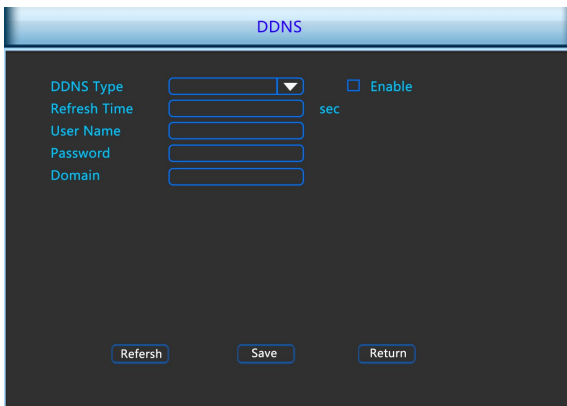

Figure 5-27

- **DDNS Type:** DDNS Types can be chosen via DDNS. (currently the list supports various DDNS, including ORAY DDNS, 3322 DDNS, TZO DDNS and DYNDNS DDNS. These DDNS can be multiple operated according to users needs and setup.)
- **Enable:** enabling DDNS domain resolving function.

- **DDNS refresh time:** Setting refresh time, the number in seconds.
- **User name:** the account registered in the DNS service provider.
- **Password:** the password to the account registered in the DNS service provider.
- **Domain name:** the domain name registered in the DNS service provider.
- **Refresh:** clicking Save to save the parameters to the device after finishing all the parameters setup and click Refresh to acquire the latest configuration information of the device.
- **Save:** saving the parameters in the DDNS setup interface.
- **Return:** going back to the former management interface.

When DDNS is successfully configured and enabled, you can type in the registered domain name in the IE address bar directly to link the Web page of the device.

5.3.5 Advance Option

Left-click "Advance Option" in the main menu, as shown below, including disk management, user accounts, equipment upgrades, and configuration of four sub-menu preview 5-28.

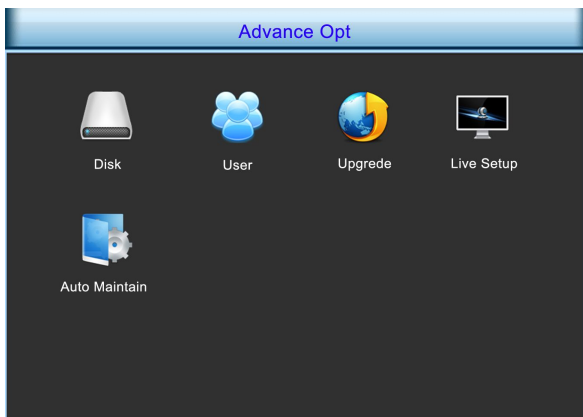

Figure 5-28

5.3.5.1 Disk

Click "Disk" icon under "Advance Option", will switch to the interface of Disk Manage, as shown in Figure 5-29.

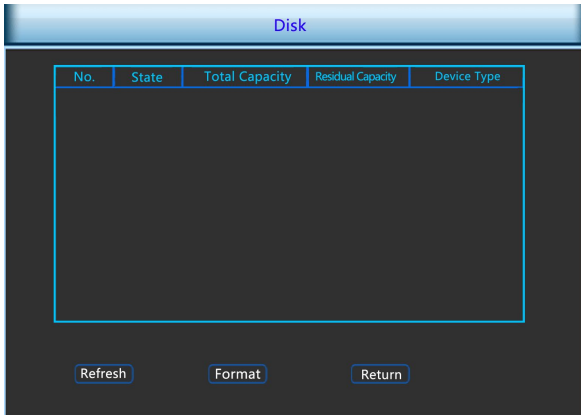

Figure 5-29

If the devices have connected the HDD successfully, the HDD manage list will show the information of HDD. You have to format the HDD if the HDD is the first time to connect; If the system detects that do not need to format the hard disk, the HDD status will displays "normal"; If do not connect successfully or could not detect hard disk, will displays the warning "Not connected the HDD".

- **HDD No.:** The number of HDD that connect the system.
 - **State:** Detect the current working status of HDD, you could use only that displays "normal"; After formatting is completed, you need to restart DVR, the status displays "in use".
 - **Total Capacity:** The total available HDD capacity, the single HDD capacity can not exceed the maximum capacity: 4TB.
 - **Residual Capacity:** Display the residual capacity of the current HDD;
 - **Device Type:** SATA.
 - **Refresh:** Refresh HDD information in the list;
 - **Format:** Formatting the HDD, select the HDD that needs to be formatted firstly, and then click the "Format" button, pop-up warning dialog "formatting will result in the selected HDD recording data loss, confirm that you want to continue?", If confirm to format then click on the "OK" button, otherwise click "Cancel".
 - **Return:** Return to the former management interface.
- Note:** After formatting the HDD, you need to restart the device.

5.3.5.2 User

Click "User" in "Advance Option" interface, then interface of user management will be out. As followed Figure 5-30 shows.

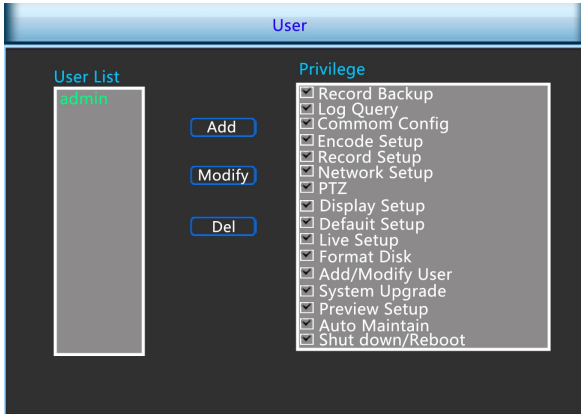

Figure 5-30

- **User List:** List added users. "admin" is super user/administrator, and we cannot change its privilege, but only its password. Other general users have no privilege of adding, modifying or deleting.
- **Privilege:** Privilege list of users. It includes PTZ control, playback, parameter setup, query log, advanced configuration, channel management, query parameter, backup /shut down/ logout.
- **Add:** To add a new user, which can be only done by super administrator--admin. Click "Add", then enter user name and password, select privilege and save the parameters.
- **Modify:** To change information of users, which can be only done by super administrator--admin. First, choose a user, click "modify", then enter old password and new password, modify privilege, and finally save the parameters.
- **Delete:** To delete user, which can be only done by super administrator--admin.
- **Return:** Return to former interface.

5.3.5.3 Upgrade

Click "Upgrade" icon under "Advance Option", transfer to the interface of Upgrade Management, As followed Figure 5-31 shows.

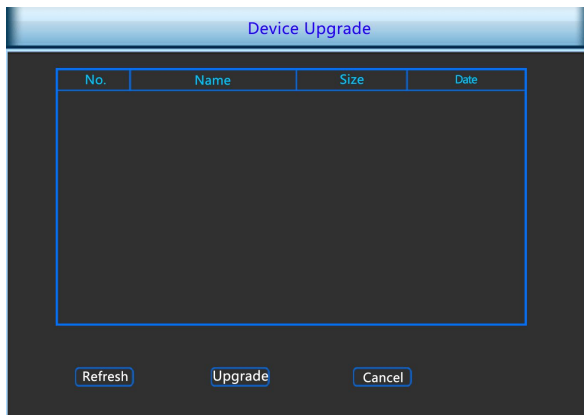

Figure 5-31

If the device have detected upgrade files in the U disk, the related information of upgrade package (number, name, size, date) will be displayed.

U disk Upgrade steps: Copy the upgrade file (named should be the format update_dvr.tgz) to the root directory of U disk, connect this U disk to the device's USB port, if did not display the upgrade file in the list ,please refresh the interface (If the upgrade package still cannot be searched out , please check whether the USB port connect well with the U disk , and also check whether the upgrade file name is correct). After the upgrade file appears, select the upgrade file, click the "upgrading" and begin to upgrade; If you don't want to upgrade, click cancel to return.

Note: During the upgrading process, please do not cut off the power or take off your U disk. After the upgrading, your system will restart automatically. (This process will takes about 3 to 5 minutes.) Here, we advice you to restore factory Settings after the upgrading.

5.3.5.4 Live Setup

Double click left mouse setting the scene, enter setting the scene interface, shown in Figure 5-2.

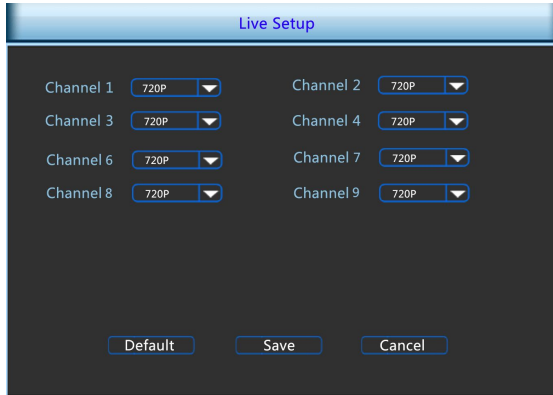

Figure 5-32

- **Channel list:** Set video input type of the channel, set to 720P or 960H.
- **Default:** Restoration site parameters, set to default values.
- **Save:** Save the parameter values of the current interface settings.
- **Cancel:** Do not save the parameter values of the current interface settings, return to the previous interface.

5.3.5.5 Auto Maintain

Click the automatic maintenance icon in the advanced option interface and the automatic maintenance setup interface will pop up, as followed Figure 5-33 shows.

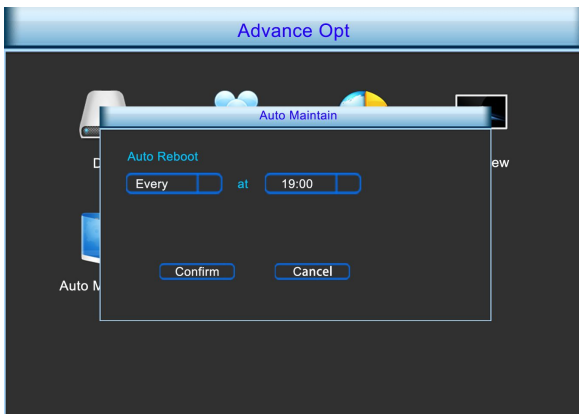

Figure 5-33

User can themselves set the system to be automatically rebooted. Automatically rebooting system can be set in a fixed time periodically. Click OK to save after finishing the setup or click Cancel otherwise.

5.3.6 Shut Down

Click "Shut Down" icon in the main menu, move on to shut down the system interface. Therefore, the system can be canceled, restarted, and shut down, as followed Figure 5-34 shows..

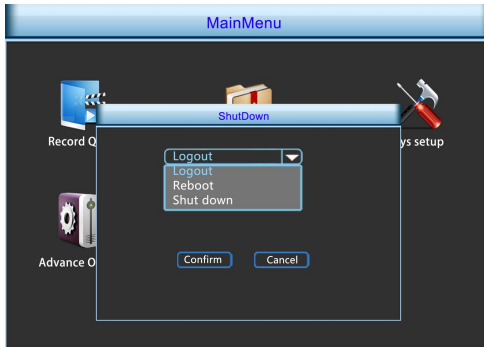

Figure 5-34

- **Logout:** Logout the current user, switch to user login interface.
- **Reboot:** Reboot the device.
- **Shut down:** Shut down the device, just like computer safe shutdown mode.

6 WEB Operation

6.1 Active X install

To make sure DVR connects to Internet successfully, open IE Browser, input required IP address, the default setting is 192.168.1.188, and then the Active X will be downloaded and installed automatically

Notice: 1.For WIN 7, could have problems for backup and recording, if so, please check the Admin setting, procedure as follows:

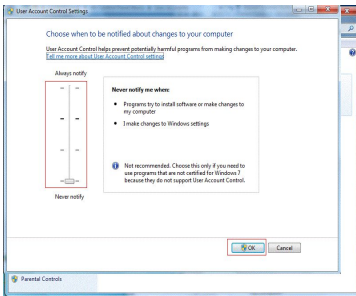

WIN7-1

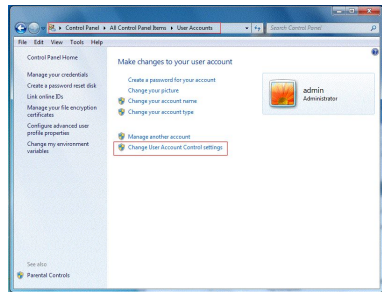

WIN7-2

2.The Active X can't be loaded? Please adjust the security level and firewall setting to the lowest, and make some adjustment to IE as well: Tool-Internet Option- Custom level-ActiveX- enable all the options below ActiveX and click OK! Finally, the Active X will be downloaded and installed automatically, please refer to the Figure 6-1.



Figure 6-1

6.2 Accessing by Web Browsers

After the plug-in is installed, login interface as below Figure 6-2, Input the user name and password and click Login. The default user name is admin, and the password is 12345, click the login then can remote login.

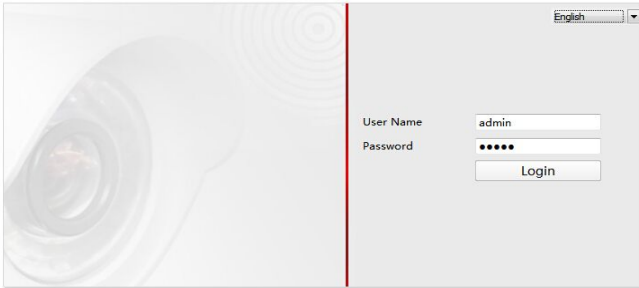

Figure 6-2

6.3 Live Video

6.3.1 View Images

After logging the client successfully, entering live view window as shown in Figure 6-3.

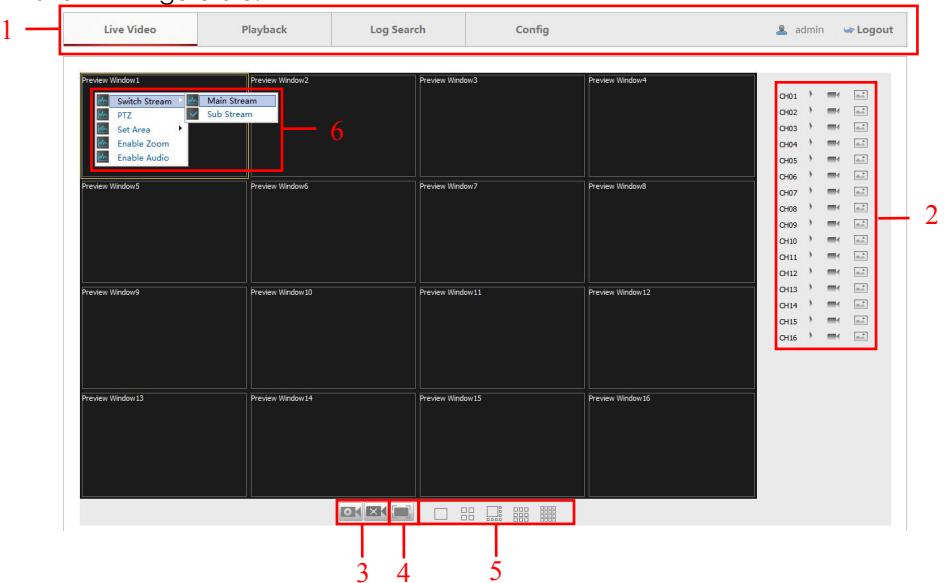







Figure 6-3

1.System Menu. Including Live Video, Playback, Log Search, Config and Logout.

2.Real-time Monitoring Channel. Open/Close Preview, Local Video and Photograph.

Icon	Description
CH1-CH16	Preview Channel.
	Open or close corresponding preview channel.
	Manually start/stop recording, the video saves in computer hard disk.
	Manually capture the picture, the picture saves in computer hard disk.

3.Open/Close All Channels Preview Image

Icon	Description
	Open all preview channels.
	Close all preview channels.

4.display modes to choose. In this display mode, you can exit full Screen by right-click and select "Exit MAX Screen".

5.Preview Window Switch. from left to right are: Single Channel, Four Channel, Eight Channel, Nine Channel, Sixteen Channel.

6.Menu Bar. preview window, click the right mouse button in the drop-down menu, you can enter the main stream sub stream switching, PTZ settings, motion detection area setting, electronic amplification and Turn on microphone operation.

6.3.2 PTZ

In the PTZ interface as shown in Figure 6-4, you can use the PTZ control buttons to realize pan/tilt/zoom control of the camera.

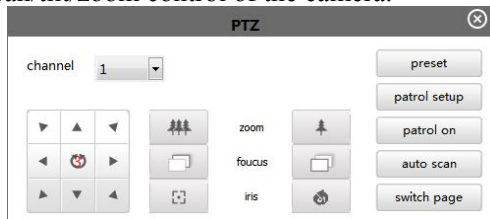





Figure 6-4

To realize PTZ control, the camera connected to the DVR must support the PTZ function. You can click the zoom/focus/iris buttons to realize lens control.

There are 8 direction arrows $\swarrow, \searrow, \leftarrow, \rightarrow, \uparrow, \downarrow, \swarrow, \searrow$ in the PTZ window when you click and drag the mouse in the relative positions. For the cameras which support lens movements only, the direction buttons are invalid. The patrol

setup relevant parameters are same with DVR setting

Icon	Description
	Zoom in/out
	Focus near/far
	Iris +/-

6.4 Playback

Click Playback on the menu bar to enter playback interface as shown in Figure 6-5.

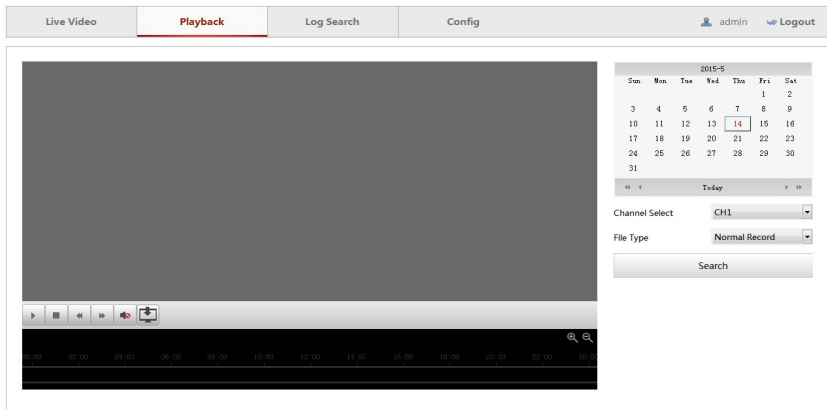



Figure 6-5

Select the date in this interface, videos of associated channels can be checked according to the video types. You can also click  to zoom out/in the progress bar. You can Click  to choose the file paths locally for downloaded playback video files in download video interface. Relevant parameters should be the same with the DVR port.

6.5 IE Log search

You can find specific log information by log query.

Specific steps: Set up the type and time of the journal you need (as below Figure 6-6, you can recall the calendar to choose the date by clicking the blank frame of start time and begin time), click "query" to query the journal, if there has recordings of journal, it will display on list.

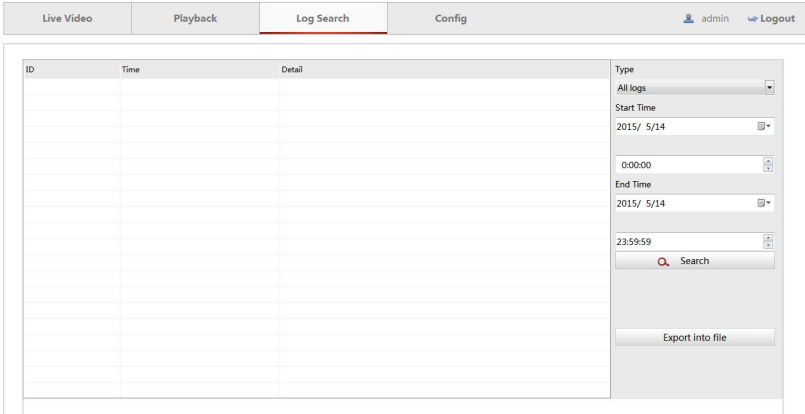

Figure 6-6

6.6 Config

6.6.1 Local Configuration

In the local configuration, users can set the playback parameters , Record files and snapped images of the saving path, shown in Figure 6-7.

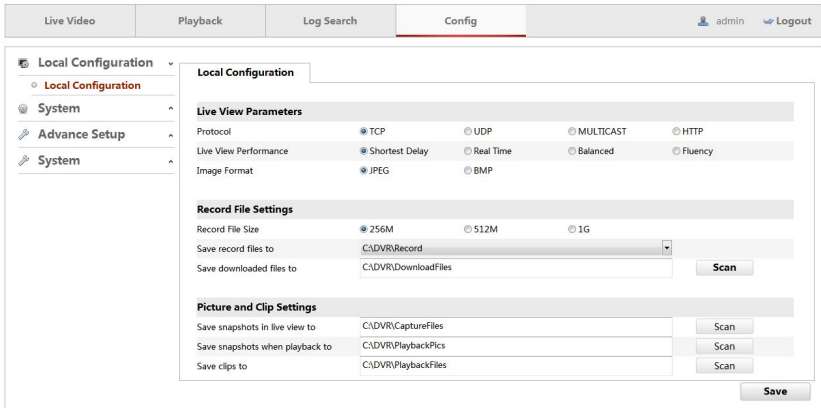

Figure 6-7

parameters	Description
Protocol Type	TCP, UDP, MULTICAST and HTTP are selectable
Live View Parameters	Set the live view performance to Shortest Delay, Real Time, Balanced or Best Fluency
Image Format	Choose the image format for picture capture.

Record File Size	Select the packed size of the manually recorded and downloaded video files to 256M, 512M or 1G.
Save record files to	Set the saving path for the manually recorded video files.
Save downloaded files to	Set the saving path for the downloaded video files in playback mode.
Save snapshots in live view to	Set the saving path of the manually captured pictures in live view mode.
Save snapshots when playback to	Set the saving path of the captured pictures in playback mode.
Save clips to	Set the saving path of the clipped video files in playback mode.

6.6.2 System

6.6.2.1 Common

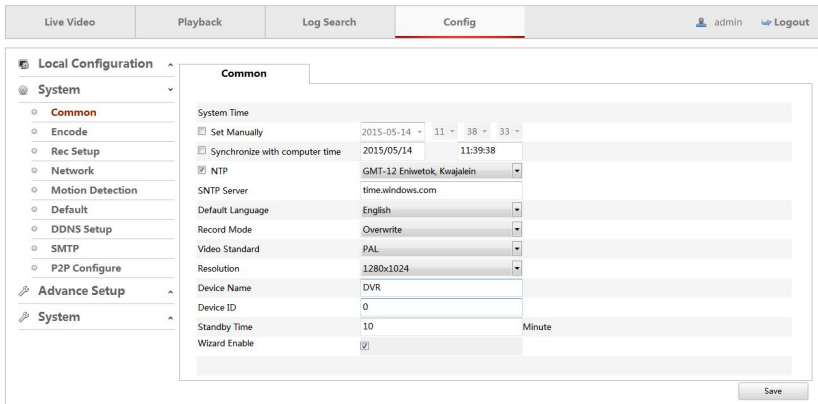

Figure 6-8

As shown in Figure 6-8, setting up the current system time of device, date, system language, display resolution and other information.

Parameter	Specification
Set manually	Manually set the system time
Synchronize with computer time	Synchronizing with computer time.
Ntp	It displays the current time zone where the device can be set according to the actual situation

Sntp server	use the default SNTP server (time.windows.com) or change to another server with which users are familiar.
Default language	Set up the device language, you can change the language as you need.
Record Model	Can be set to automatically overwrite when the hard disk is full.
Video Standard	The video standard of device must be same with the IPC.
Resolution	HDMI and VGA output resolution of device can be set.
Device Name	Name of the device can be filled according to the actual needs.
Device ID	Reserved.
Standby time	Lock time of local time can be set, the time is 1-120 minutes.
Wizard Enable	Once you check the box here, system will go to the startup wizard directly when the system restarts the next time. Otherwise, it will go to the login interface.

6.6.2.2 Encode

The interface of encoding parameters as below Figure 6-9.

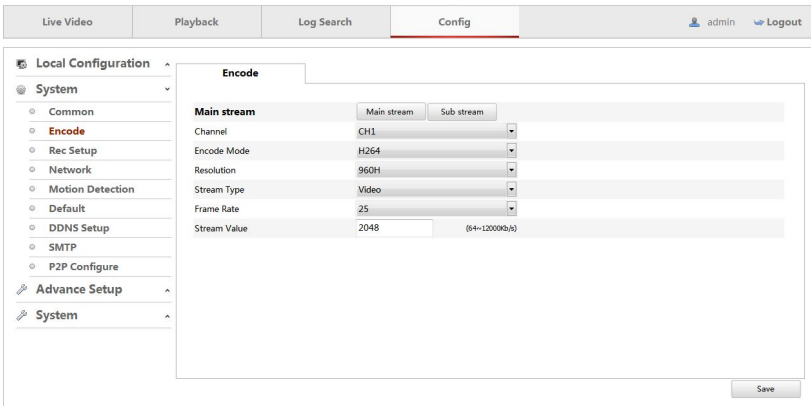

Figure 6-9

You can get parameters of Main-stream and Sub-stream of IPC device of channel access (encode mode, resolution, stream rate, frame rate and the value of the stream), also can set the value of stream of Main-stream and Sub-stream of IPC device by the interface. relevant parameters are same with DVR setting.

6.6.2.3 Rec Setup

Rec Setup interface is shown in Figure 6-10.

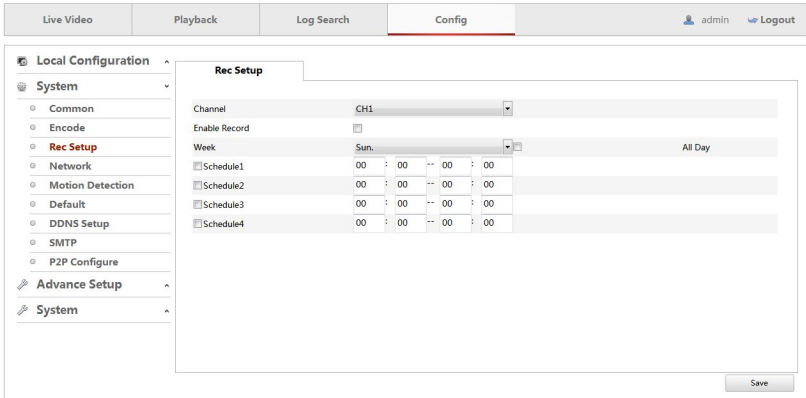

Figure 6-10

You can set up the channel recording as timetable by the interface, relevant parameters are same with DVR setting.

6.6.2.4 Network

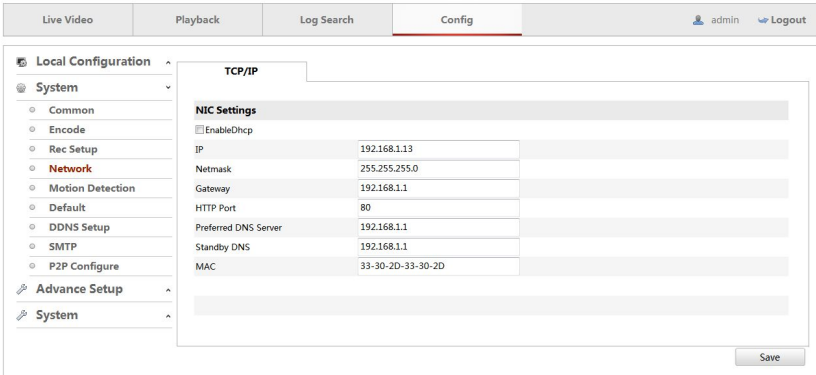

Figure 6-11

As shown in Figure 6-11, the IPv4 address, Netmask, Gateway, DNS, HTTP port and related parameters of the device can be set by the interface. If you want to be assigned the IP address you can check the checkbox to enable the DHCP.

Related parameters setting consistent with DVR client; The IP address effects at once after you modify, don't need restart DVR device.

6.6.2.5 Motion Detection

Motion detection interface is shown in Figure 6-12.

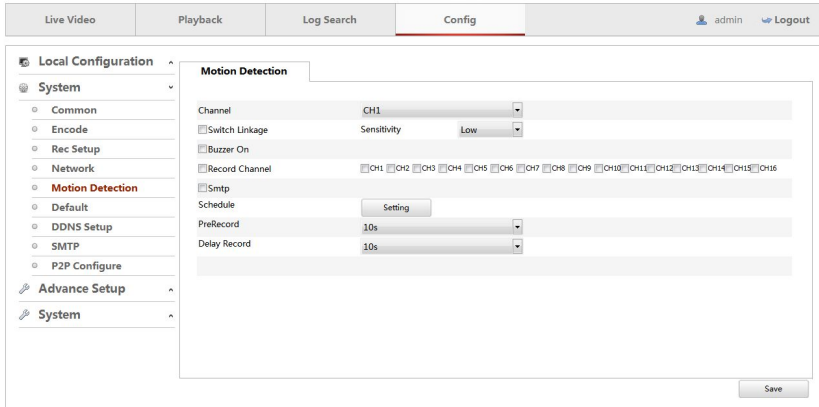

Figure 6-12

You can set the channel region detection by the interface, and buzzer alarm, smtp alarm and Video motion detection, the relevant parameters consistent with DVR-side settings.

6.6.2.6 Default

You can restore the default parameters of DVR by remoting, the method of setting is same with local setting, as below Figure 6-13.

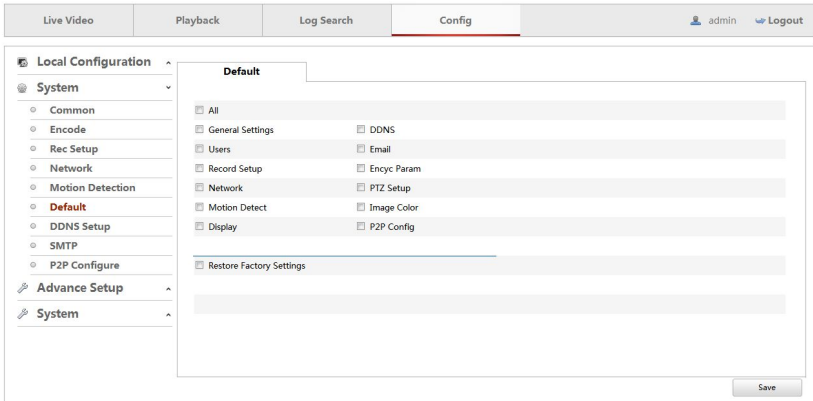

Figure 6-13

6.6.2.7 DDNS Setup

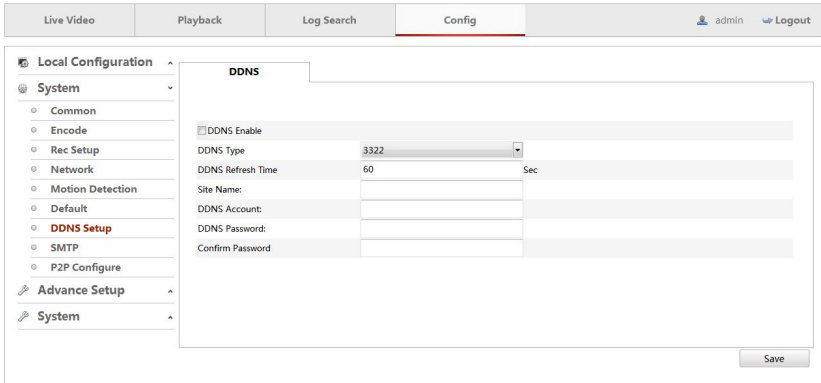

Figure 6-14

As shown in Figure 6-14, you can use the Dynamic DNS (DDNS) for network access , Registration on the DDNS server is required before configuring the DDNS settings of the camera. relevant parameters setup should be the same with the DVR port.

6.6.2.8 SMTP Setup

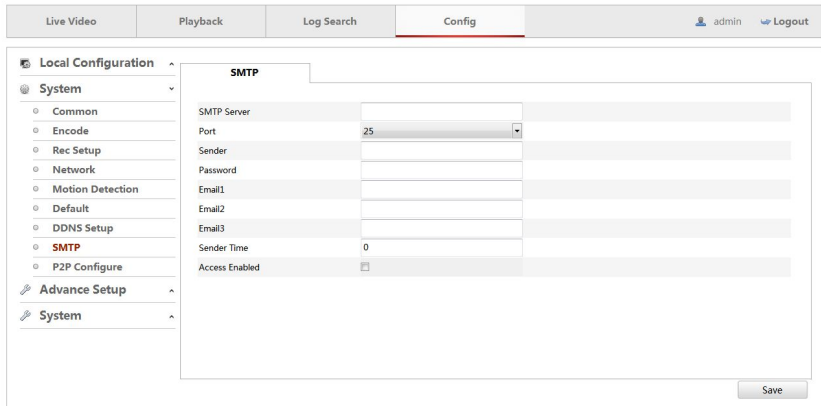

Figure 6-15

As shown in Figure 6-15, when alarm message appears, mails can be sent to designated mail address through the setup of this page. The relevant parameters should be set up the same with the DVR port.

6.6.2.9 P2P Setup

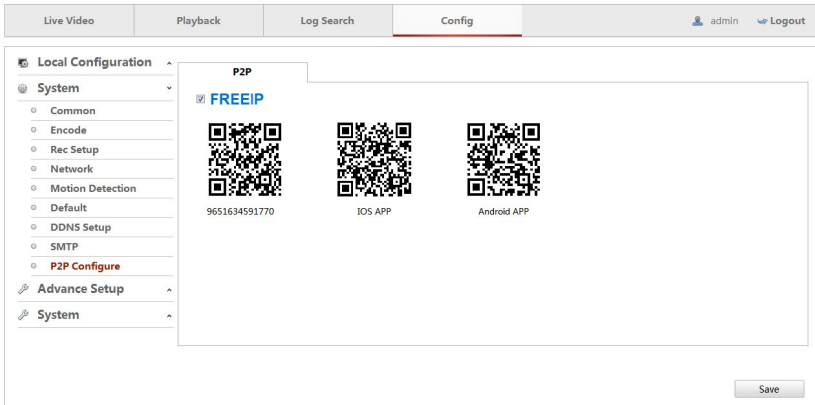

Figure 6-16

As shown in Figure 6-16, you are able to manage the device via Freelp Cloud P2P website, or EZVIZ Freelp P2P client, which is a mobile phone app.

6.6.3 Advance Setup

6.6.3.1 Disk

You can format the disk (when you use the hard disk to record first time, you need format the disk first), you can find the information of hard disk (Disk Number, State, Total capacity, Residual Capacity and Device Type), as below Figure 6-17.

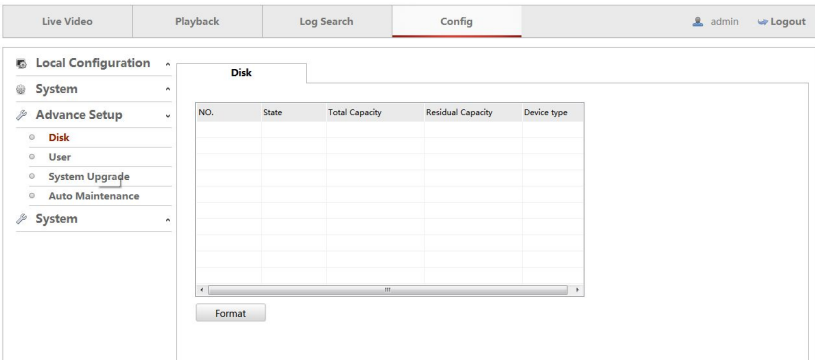

Figure 6-17

6.6.3.2 User

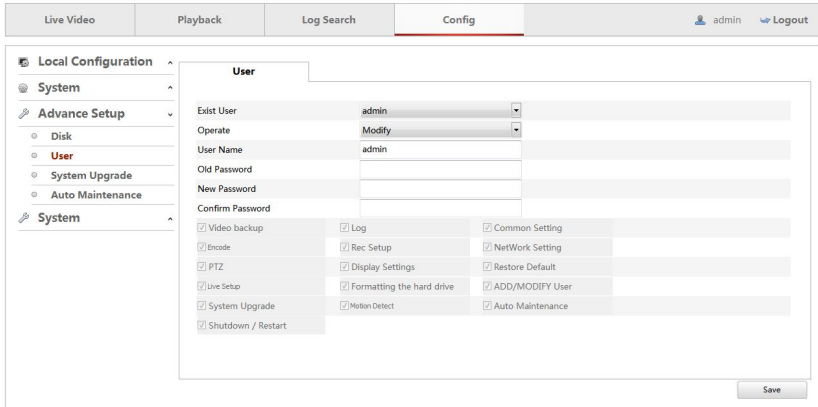

Figure 6-18

As shown in Figure 6-18, you can add or delete user, modify the information and rights of user by the interface; Related parameters setting consistent with DVR client.

6.6.3.3 System Upgrade

You can restart and update the device of DVR by remoting, as below Figure 6-19.

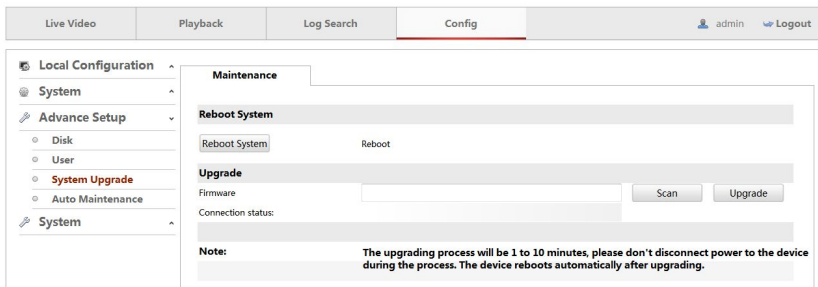

Figure 6-19

6.5.3.4 Auto Maintenance

as below Figure 6-20, users can set the timer to reboot the system voluntarily.

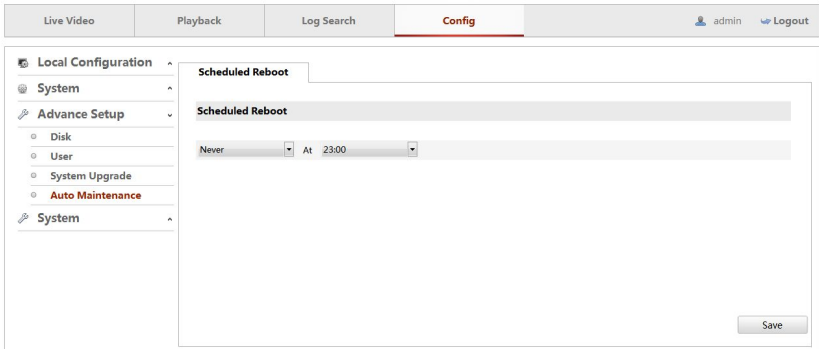

Figure 6-20

6.6.4 System

6.6.4.1 Version

User can check the version information of the system, including serial number of product, model number, version number and version date. As below Figure 6-21.

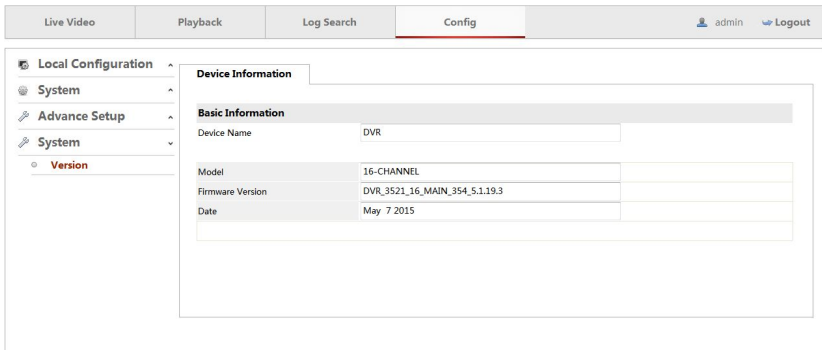
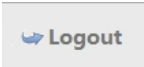

Figure 6-21

6.7 Logout

Click the logout icon  , back to the login screen.

7 Appendix

7.1 Q&A

1. How to do when can't detect the hard disk?

Answer: If the system does not detect the hard disk, kindly please check the data line and the power line of hard disk whether are connected well, whether there is a problem about the interface of hard disk on the motherboard, or kindly please check hard disk whether is supported by the DVR in specification.

2. After modifying password, what can you do when you forget the password?

Answer: When the administrator forget password, kindly please get in touch with our technical staff. The easy to remember and relatively safe password is recommended when you set the password (if you have security needs, kindly please don't try to set simple passwords such as 123).

3. what results will maybe happen due to the heat when DVR is working?

Answer: It will produce some heat when DVR is working, kindly please put the DVR in the place where is safe and ventilated to stop the stability and life of the system be affected due to long-term high temperature of DVR.

4. Whether can use if i install the hard disk drive of computer to DVR?

Answer: If the hard disk you use can be supported by the system of DVR, it can work, but you need note, if the DVR begins to work, all datas in your hard disk will loss.

5. Whether can playback when recording?

Answer: Yes.

6. Whether can remove a part of video recordings of hard disk of DVR?

Answer: Considering the security of document, you can't remove a part of video recording, if you need remove all video recordings, you can format the hard disk.

7. Why can't login to DVR client?

Answer: Kindly please check configuration of Digitalconnection whether is right, connection of RJ-45 interface whether is fine, if also can't work, kindly please check whether the user name and password are right.

8. Why can't find any recording information when playback?

Answer: Kindly please check whether the connection of data line of hard disk is good, whether the time of system is changed, whether the query condition that is setted can't save video files. If also have the question after restarting, kindly please check whether the hard disk is damaged.

7.2 Maintenance

1. When DVR shutdowns, kindly please don't turn off the power switch directly, should use the shutdown button of system to avoid data loss or damage of the hard disk.
2. Ensure DVR away from high temperature heat source and place.
3. Remove the dust deposited in the body timing, keep the good ventilation around chassis, it is good for radiating.
4. About the audio/video signal line and RS-485 interfaces, kindly please don't hot swap, or these port will be damaged easily.
5. Check the HDD power cable and data cable of the DVR regularly and look whether they are aging.
6. Avoid the audio/video signal effected by other circuits and devices as much as possible, prevent the hard disk damaged by electrostatic or induced voltage.