



Network Video Recorder
User manual



Declaration:

Copyright ©2014

Without the written permission of the company, any company or individual should not extract, duplicate part of or all of contents of this manual and no spreading in any form.

As the upgrade of the products or other other reason, the contents of manual will be upgraded aperiodically. Unless otherwise stipulated, the manual is used as a instruction. All statements, information and suggestions of the manual does not constitute any ostensive or implied guarantee.

Product in kind prevail, final interpretations are owned by manufacturer.

Safety Precautions

Notice:

Please do not place and install equipment directly under the sunlight or near heating device.

Please do not install equipment at moist place or place with dust or soot.

Please keep equipment installed horizontally, or install equipment in a stable place, avoid the equipment falling down.

Please avoid liquid dropping on the equipment, make sure no objects filled with liquid on the equipment and prevent liquid from leaking.

Please install the device in a well ventilated place, do not block the vents of the equipment.

Please only use equipment within rated input/output.

Please do not disassembly at liberty.

Please transport, use and reserve the equipment within allowing humidity and temperature.

Warning:

Please do use the battery as requested, or it may lead to a battery fire, explosion or risk of burning!

Please use the same type of battery when changing it.

Please do use recommended cord sets(power cords), do use within the rated specifications.

Contents

Declaration:	I
Safety Precautions	II
Contents	III
1 Outline and Feature	1
1.1 Outline.....	1
1.2 Function Features:.....	1
2 NVR Appearance	3
2.1 The Front Panel.....	3
2.1.1 The Front Panel (For informational purposes only, subject to object)	3
2.2 Rear Panel.....	4
2.2.1 Rear Panel (For informational purposes only, subject to object)	4
2.3 Mouse Instructions.....	4
2.4 Input Method Introduction.....	5
3 Connecting NVR	6
3.1 Hard Disk Installation.....	6
3.2 Device Connection.....	7
4 NVR Startup	8
4.1 System Initialization.....	8
4.2 Boot wizard.....	8
4.3 Preview Interface.....	11
4.4 Preview Control.....	12
4.5 Quick adding function.....	13
5 NVR Menu	14
5.1 Right click mouse.....	14
5.2 Main Menu Navigation.....	15
5.3 Main Menu.....	15
5.3.1 Record Query.....	16
5.3.2 System Information.....	18
5.3.2.1 Log Information.....	19
5.3.2.2 Version Information.....	19
5.3.3 System Setup.....	20
5.3.3.1 Common Set.....	20
5.3.3.2 Encoding parameters.....	22
5.3.3.3 Rec Setup.....	23
5.3.3.4 Network.....	24
5.3.3.5 Motion Detection.....	26
5.3.3.6 PTZ Setup.....	27
5.3.3.7 Display.....	29
5.3.3.8 Restore Default.....	31
5.3.3.9 Image Color.....	31
5.3.3.10 DDNS.....	32
5.3.3.11 P2P Config.....	32
5.3.4 Remote Device.....	33
5.3.4.1 Manual Add.....	34
5.3.5 Advance Option.....	35
5.3.5.1 Disk.....	35
5.3.5.2 User.....	36

5.3.5.3 Upgrade.....	37
5.3.5.4 Preview.....	38
5.3.5.5 Auto Maintain.....	39
5.3.6 Shut Down.....	40
6 WEB Operation.....	41
6.1 Active X install.....	41
6.2 IE Login.....	42
6.3 IE Login Interface.....	42
6.4 Basic Setup.....	43
6.4.1 System.....	43
6.4.1.1 Common.....	43
6.4.1.2 Network.....	44
6.4.1.3 User.....	45
6.4.1.4 SMTP Setup.....	45
6.4.1.5 DDNS Setup.....	46
6.4.1.6 P2P Configure.....	46
6.4.2 Channel.....	47
6.4.2.1 Channel Setup.....	47
6.4.2.2 Encode.....	47
6.4.2.3 Motion Detection.....	47
6.4.3 Rec Setup.....	48
6.4.3.1 Common.....	48
6.4.3.2 Playback.....	48
6.5 Advance Setup.....	49
6.5.1.1 Disk.....	49
6.5.1.2 Device Manage.....	50
6.5.1.3 Default.....	50
6.5.1.4 Log information.....	50
6.5.1.5 Auto Maintenance.....	51
6.5.1.6 Version.....	51
6.5.1.7 Storage.....	52
6.6 Logout.....	52
7 Appendix.....	53
7.1 Q&A.....	53
7.2 Maintenance.....	54

1 Outline and Feature

1.1 Outline

The item is a high-performance network DVR, characterizing local previewing, multi-picture division displaying & local real-time storage of recorded files. It supports shortcut operating of mouse and remote managing and controlling. It has two ways of storage--Front storage & client-side storage. Front-end monitoring points can be located anywhere on the network without geographical restrictions. Combined with other front-end equipment such as network cameras, network video server network, professional video surveillance system software to form a powerful safety monitoring network, in its network deployment system, focal point and monitoring points simply connect a network cable, no need to lay monitor video cable, audio cable etc from center to monitoring points, easy construction, low cabling costs and low maintenance costs.

1.2 Function Features:

- H.264 video condense format, Support 1080P/720P/D1 resolution network camera input.
- G.711U audio condense format.
- Windows-style user interface, embedded real-time Linux3.0 operating system.
- Support preview, recording, play back, backup.
- Supports dual stream.
- USB2.0, support backup, software upgrading & mouse operating.
- Supports Chinese and English switch.

Function	Function Brief Introduction
Real-time	Two video output, VGA & HDMI output.
Record	H.264 standard compression, timing recording.
Storage	Support SATA Hard Disk interface, video hard drive storage .
Paly back	Support 1~4 channel playback and network mutil-channel play back.
Backup	Support NVR backup to USB memory sticks, portable hard drive or a network backup to hard drive.
Network Operating	Support for remote client access, improve system safety.
Mouse Operating	Support USB mouse operating, easily and quickly set system parameters.
Pan-tilt Control	Though Onvif protocol, fulfill control functions of network dome camera. PTZ preset point, automatic cruise.

2 NVR Appearance

2.1 The Front Panel

2.1.1 The Front Panel (For informational purposes only, subject to object)

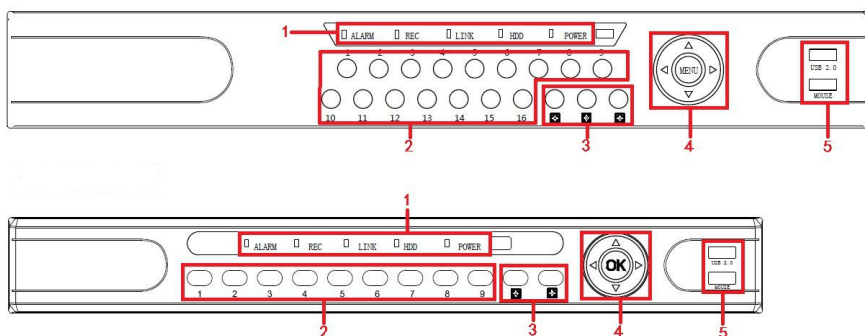

No.	Button or indicator light	Function
1	Indicator light	Normal working hours, the corresponding indicator light turns
2	Channel button	Select single channel full screen display
3	Multi-channel preview	Switch and display 4,9,16 channel
4	Direction button	Move the button up or down, right or left to select menu
5	USB2.0	Connect mouse or USB memory stick backup

2.2 Rear Panel

2.2.1 Rear Panel (For informational purposes only, subject to object)

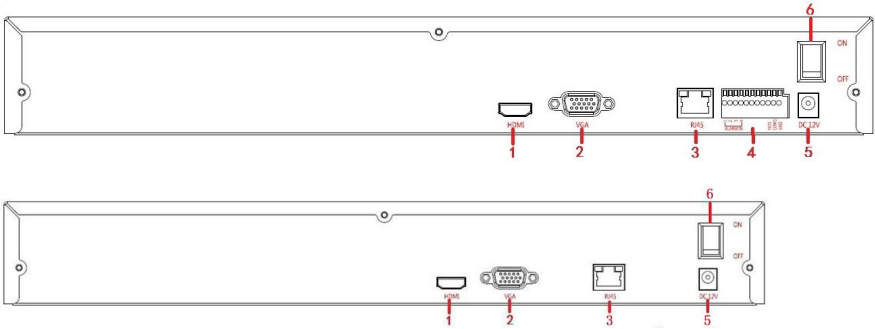

No.	Interface	Connection instruction
1	HDMI	Connect HDMI display device
2	VGA	Connect VGA display device, like computer
3	RJ-45	Ethernet interface, connect network cable
4	Alarm terminals	Three sets of alarm input, a set of alarm output
5	Power supply interface	DC12V, NVR with power supply
6	Power switch	On/off power

2.3 Mouse Instructions

Mouse instruction

Operate NVR through mouse left button, right button & scroll wheel.

Mouse actions	Function
Click left mouse button	1. Select one of the options; 2. insertion cursor, enter or modify the value of a parameter.
Click right mouse button	1. When interface not locking , click right mouse button, system menu pops up; 2. When interface locking, click right button on real-time preview interface, login interface pop up ; 3. Entered to main menu, to a submenu of PTZ control, click right mouse button on the menu interface, return to previous menu (except video playback interface); 4.

	Entered to close system interface, click mouse right button on the interface, return to preview interface.
Double-click the mouse left button	1. When real-time preview multiple channels interface, double-click maximized channel display of one channel and return to the original state; 2. Double click the password input field on the login interface; 3. setting parameters (date, time, IP address, port number, bit stream value and user password) or user names
mouse movements	Select the menu or menu item.
Mouse drag	Drag progress bar to playback video.
Slide mouse scroll wheel	1.Time setting; 2.Select the drop-down menu values;

2.4 Input Method Introduction

Input method includes lowercase and uppercase English letters. Clicking the Shift button on the left can switch the input method and the symbol“←”represents deleting incorrect input.



Uppercase English input



Lowercase English input

3 Connecting NVR

3.1 Hard Disk Installation

Hard Disk Installation:

- (1) Loosen the fixing screw on the cover, open the cover.

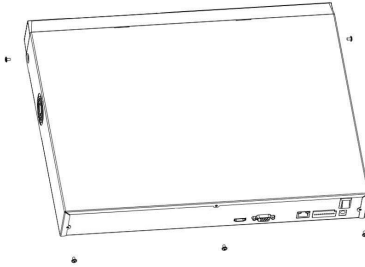

- (2) Align the four holes of hard disk button with hard disk mounting hole at the button of chassis.

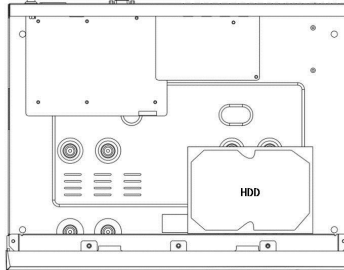

- (3) Hold the hard disk with hand, turn over the chassis, fix the hard disk with screw at the indicated position.

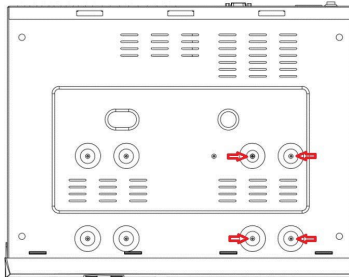

- (4) After hard disk installed, turn over the chassis, fix the cover with

screw.

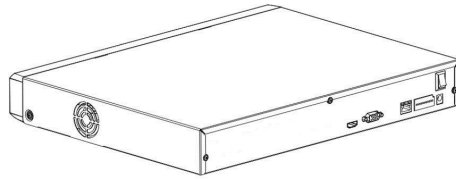

Note: 1. If user requires high performance of hard disk, we recommend the dedicated security hard disk.

2. Before replacing the hard disk, please shut off the power first and then open the case.

3.2 Device Connection

Use VGA cable or HDMI cable to transmit the NVR signal to the display. If it is a controllable PTZ, use wire to connect RS485 A cable and RS485 B cable to the corresponding RS485 interface on NVR.

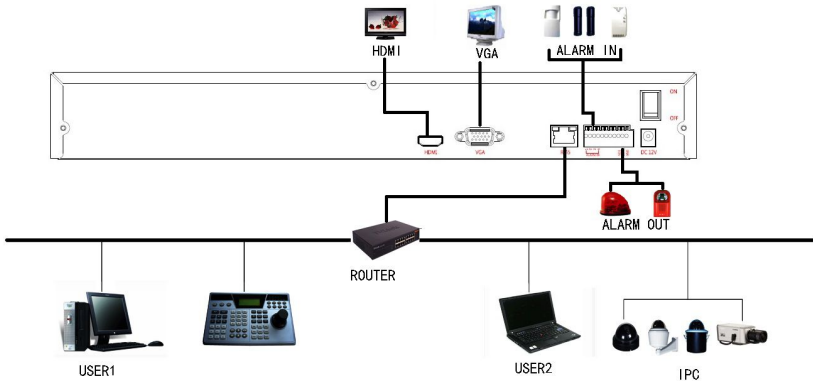

4 NVR Startup

4.1 System Initialization

After connecting the device to the display, plug in the mouse, power cable and turn on the power switch on the rear panel, then start up the NVR. The system initialization interface is as shown in Figure 4-1.



Figure 4-1

Notes: The insert figures in this user manual may not be the same as what you see on display. All figures here are just for reference.

4.2 Boot wizard

After device successfully booted up, it goes to startup wizard, see Figure 4-2. Click Cancel/Next button, you can see system goes to login interface, see Figure 4-3.

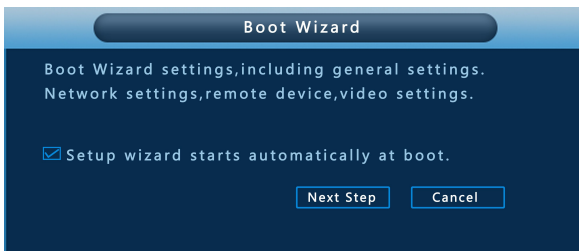

Figure 4-2

Click Next button, system goes to login interface. Then select a user name, enter the user password, select the system language and click on the login button to login the system (the default username is admin,

password is 12345). See Figure 4-3.



Figure 4-3

After logging in, you can go to Common interface, the basic configuration of the device can be set. See Figure 4-4. For detailed information, please refer to chapter 5.3.3.1.



Figure 4-4

Click Next button, you can go to Network interface, You can configure the network parameters of the device. See Figure 4-5. For detailed information, please refer to chapter 5.3.3.4.

The screenshot shows a 'Network' configuration window with a dark blue background. At the top is a rounded header with the word 'Network'. Below it, there are several rows of configuration options, each with a label and an input field: 'IP', 'Mask', 'GW', 'TCP Port', 'RTSP Port', 'HTTP Port', 'DNS', 'DNS2', 'Broadcast', and 'MAC'. To the right of the 'IP' field is a checkbox labeled 'DHCP'. At the bottom of the window, there are five buttons: 'Email setup', 'Default', 'Previous Step', 'Next Step', and 'Cancel'.

Figure 4-5

Click Next button, you can go to Mode Selection interface, and you can choose Automatic network mode or Manual mode. See Figure 4-6.

The screenshot shows a 'Mode Selection' window with a dark blue background. At the top is a rounded header with the words 'Mode Selection'. Below it, there are two radio button options: 'Automatic network mode' and 'Manual mode'. Below these is a 'Tip' section with a horizontal line above the text: 'Manual search configuration remote device, modified remote device will not automatically.' At the bottom of the window, there are three buttons: 'Previous Step', 'Next Step', and 'Cancel'.

Figure 4-6

Click Next button, you can go to Remote Device interface, You can search for and add the IPC devices. See Figure 4-7. For detailed information, please refer to chapter 5.3.4.



Figure 4-7

Click Next button, you can go to Rec Setup interface, You can configure the record schedule. See Figure 4-8. For detailed information, please refer to chapter 5.3.3.3.

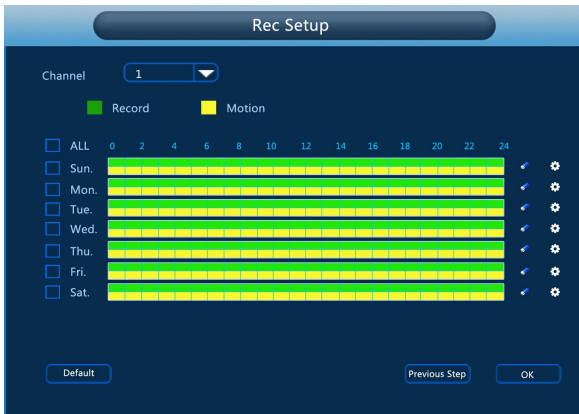

Figure 4-8

Click the OK button, the boot wizard is complete.

4.3 Preview Interface

After the system is fully booted, it will enter into the default preview interface, shown in Figure 4-9.

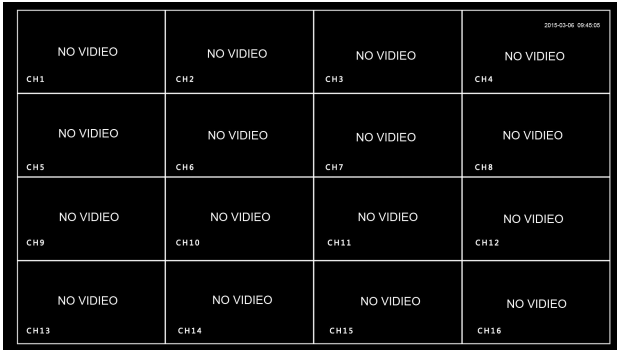



Figure 4-9

After the device normally starts up, the default setting is to preview in multi-screen display mode. Products with different channels has different amount of split screens to display. On the preview interface, you can set the appropriate date and time. On the bottom left of the screen, it shows the recording status of each video channel or alarm status icon.

- : this icon means monitoring channel is recording;
- : this icon means monitoring channel is in motion detection.

4.4 Preview Control

After the image is displayed in the preview channel, When the mouse moves within the region of the current preview channel above the middle of the screen,the control bar will pop up as shown in Figure 4-10.





Figure 4-10

1.Channel image rotation



Click on the , the current image is rotated 90 degrees channel.

2.Area amplification function

Amplification on the current channel region.Unchecked interface display , Unchecked .Once selected,the local preview may enlarge, drag the mouse to see the enlarged picture.

3.Real-time backup

Backup real-time video of the current channel to USB2.0 device.

Device can only backup one channel real-time video. Checked the current channel, interface display . Real-time backup does not start, Unchecked the current channel, Real-time backup does not start . If the real-time backup has started, then the channel is not being backed up display .

4. Quickly add remote device

Recall the remote device connection interface.

4.5 Quick adding function

At the preview menu, for the channel of unconnected IP Camera, you can quickly click the "+" icon to add the camera device when your mouse move to the middle of the channel menu. As shown in Figure 4-11 and 4-12.



Figure 4-11



Figure 4-12

- **Device search:** Search the IP address of the IPC client device.
- **Filter:** Filter the display of the searched device list.
- **Add:** Click "search", the NVR can search the IPC device which support the onvif protocol in the same LAN(local area network), the searched IPC devices can be displayed at the list. And select any IPC device in the list, click "Add", the selected IPC information can be automated add to the particular channel, then click "Save" to complete.
- **Manual Add:** please referring to Manual Add in section 5.3.4.1.
- **Cancel:** Return to the previous menu.

5 NVR Menu

5.1 Right click mouse

After login the system and back on the preview interface, click the right mouse button and it will pop up the Menu Options, shown in Figure 5-1. Then you can select options of the Main Menu, the Main Screen Switching, Playback, PTZ Control and System Shutdown. In addition, you can set the channel display as follows: single-screen display, four-screen display, eight-screen display, night-screen display, sixteen-screen display. It needs to set a specific number of channels to achieve single-screen display, four-screen display, etc.. The corresponding operation of the Main Menu Options will be illustrated in details in later chapters.

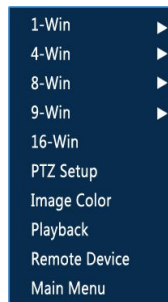
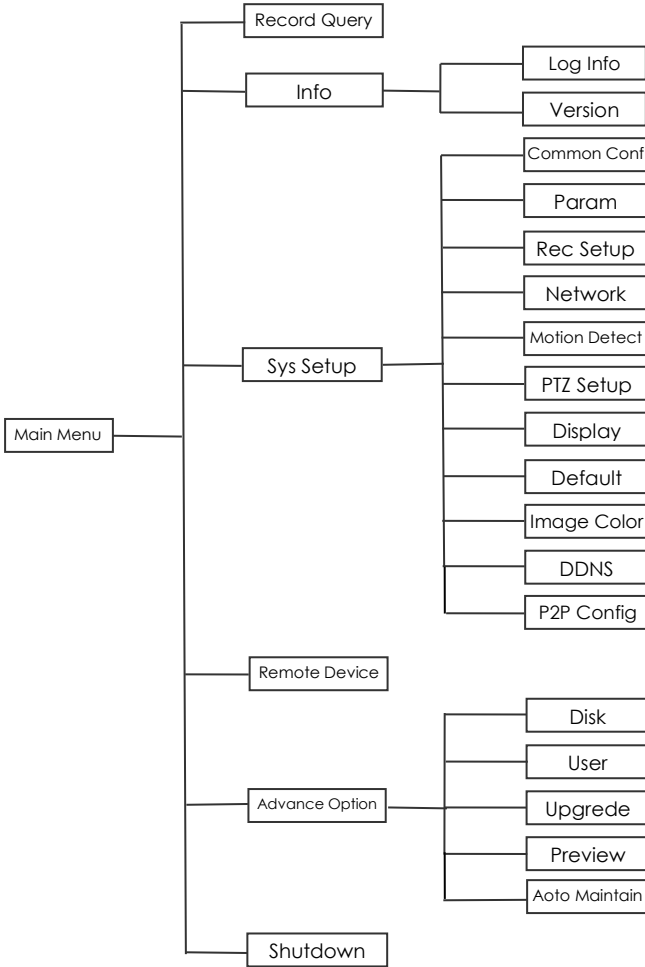

Figure 5-1

- **Single-screen Display:** Select one channel to display from CH1~CH16 .
- **Four-screen Display:** Divided into four groups to display (CH1~CH4、CH5~CH8、CH9 ~CH12、CH13~CH16).
- **Eight-screen Display:** Divided into two groups to display (CH1~CH8、CH9 ~CH16).
- **Night-screen Display:** Divided into two groups to display (CH1~CH9、CH10~CH16).
- **Sixteen-screen Display:** Display all channels CH1 ~CH16.
- **Image Color:** Click into the image color configuration interface.
- **Playback:** Click into the Playback interface.
- **Remote Device:** Click and enter the remote device configuration menu.(Detailed operation as 5.7)
- **Main Menu:** Click and enter the main menu.

5.2 Main Menu Navigation



5.3 Main Menu

Main Menu includes Record Query, System Info, System Setup, Remote Device, Advance Option, Shutdown six parts, as shown in Figure 5-2. Select one and click the left mouse button to open the corresponding next menu options.



Figure 5-2

5.3.1 Record Query

After entering the main menu, open the "Record Query" menu or right-click to choose select "right-click" menu in the preview interface, switch to video query interface, shown in Figure 5-3.

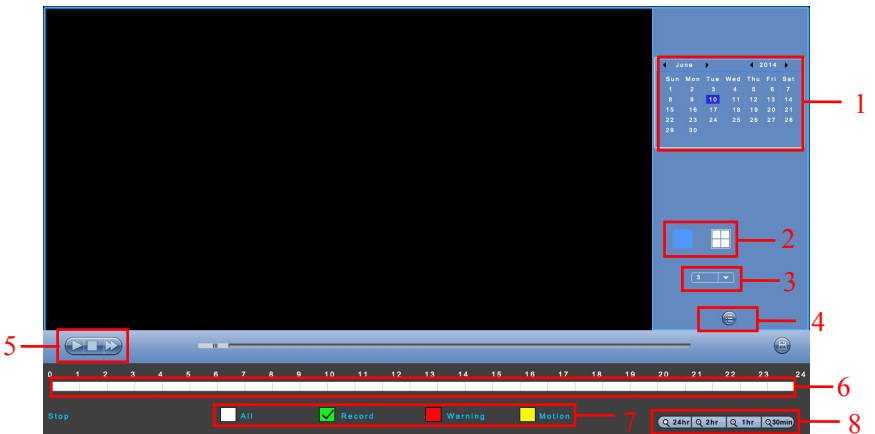

Figure 5-3

No.	Name	Function Specification
1	Calendar	In any play mode, select the recording type and channel number, click on the date you want to view, the timeline will update the recorded video for that day.
2	Playback Mode	Playback mode: single-channel, four-channel (Differ from the device with different channels)
3	Choose the Playback Channel	Select the channel number to query.
4	File List transfer button	Select the date, channel number and record type, click into the video file list. Select the desired video file, double-click the left mouse button to start playing the video file.
5	Playback Control Area	On the playback control bar, you can normally play, pause, fast forward, fast forward playback mode, you can select 1x, 2x, 4x, 8x, 16x, 1x which is played at normal speed;
6	Timeline	Query to the video file, updated for the day that recording tracks on the timeline. Under the four-frame playback mode, display the selected four channels corresponding to four playback timeline, other playback mode displays only one playback timeline. Click on the green area to start from that point of time for playback.
7	Select video type	Select the type of video, you can choose the type for all types of video, timed recording, alarm recording and detection recording.
8	Timeline unit selection	Including 24h, 2h, 1h and 30min, the smaller units of time the greater the proportion of time zoom, you can adjust the exact point in time to play back video on the timeline.

In the file list bar, you can see the start time of the video file, video type, select a video file, you can view the video of recording start time, end time and file size, as shown in Figure 5-4.

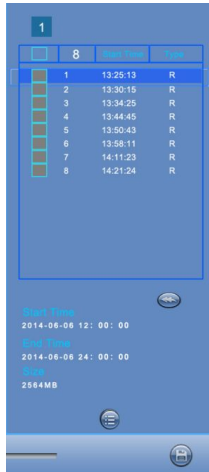



Figure 5-4

In the file list box, click to choose the video file selection box  , showed icon "√", click this icon  to backup the video files (external U disk), the files are "avi" format. You could also click to choose multiple video files selection box to backup those video files, users can also cancel this icon "√" in the backup operation menu in the file list box, delete those video files that unwanted.

5.3.2 System Information

Left-click the icon of "Info" in the main menu, shown as Figure 5-5 below, including "Log info" and "Version" of two sub-menus.

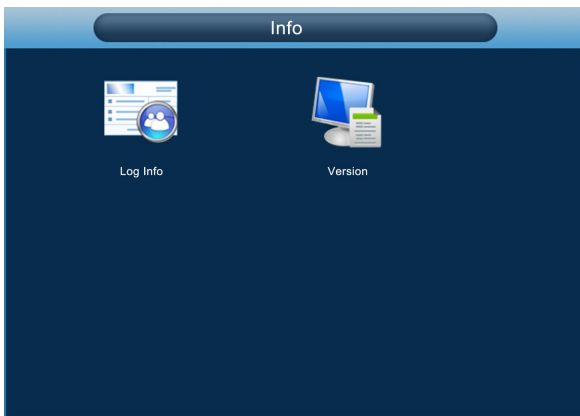

Figure 5-5

5.3.2.1 Log Information

Under the "Info" menu, please click "Log Info", and then switch to the interface of "Log Info". As shown in Figure 5-6.

The screenshot shows a web-based interface titled "Log Info". At the top, there is a dropdown menu labeled "Type" with "All Logs" selected. Below this are two input fields for "Start Time" and "End Time". To the right of the "End Time" field is a "Query" button. Below the input fields is a table with three columns: "No.", "Time", and "Event". The table is currently empty. At the bottom of the interface, there are four buttons: "PgUp", "PgDn", "Clear", and "Cancel".

Figure 5-6

Viewing System Logs to access the logs and search for these events on one day a certain period of time.

- **Type:** Select the type of information you request.
- **Start Time/End Time:** Enter the time to find the logs.
- **Search:** Search for logs according to criteria.
- **PgUp/PgDn:** You can view all logs through the PgUp/PgDn.
- **Clear:** Clear all information.
- **Cancel:** Return to the former menu.

Specific Steps: Enter the log search menu, set search parameters, click the Search button to begin search, If logs matching the search criteria are found, it will be displayed in a list, To view all logs through PgUp/PgDn button.

5.3.2.2 Version Information

Click "Version" icon under "Info", switch to interface as Figure 5-7 shows.



Figure 5-7

Users can find system version, including model number, system version, Version Date.

- **Model number:** Number of main board.
- **Version:** System version number.
- **Date:** Program created date.

5.3.3 System Setup

Left-click the icon of "Sys Setup" in the main menu, shown as Figure 5-8 shows.



Figure 5-8

5.3.3.1 Common Set

Click "Common Config" icon under "Sys Setup", switch to interface as Figure 5-9 shows.

The screenshot shows a 'Common' settings window with the following fields and controls:

- System Time: 2015-02-6 13:24:54
- Default Language: English (dropdown)
- Record Mode: Overwrite (dropdown)
- Device ID: 0
- Video Standard: PAL (dropdown)
- Standby Time: 30 Minute
- Time Sync: Modify (button)
- Wizard Enable:
- Device Name: (empty text field)
- Buttons: Default, Save, Cancel

Figure 5-9

- **System Time** : System date and time of NVR.
- **Default Language** : the default language of the system boot, which is English, but, at present, also supports Chinese, Polish, Czech, Russian, Thai language, Hebrew, Persian, Bulgarian, Arabic, German, French, Portuguese, Turkish, Spanish, Italian, and Hungarian.
- **Record Mode** : Overwrite automatically, ie., NVR will automatically cover the previous record if hard disk is full.
- **Device ID** : Reserved.
- **Video Standard** : PAL or NTSC.
- **Standby Time**: It means standby time of system without operation for NVR. If time exceeds the standby time, then you should re-login in system so as to operate NVR. Default standby time is 30 minutes. And standby time range is: 1 to 120 minutes.
- **Wizard Enable**: Select the check box wizard, open boot wizards function .
- **Default** : Restore all specifications or parameters of common setup to be factory default specifications.
- **Save**: To save specifications or parameters of common setup.
- **Cancel** : Return to the former interface.

The option Time Sync enables network time sync. Click Modification button and the Time Sync setup interface will pop up like diagram 5-10. Then type in the IP address of Time NTP Server, choose the Time Zone where the device locates and click OK to save it.

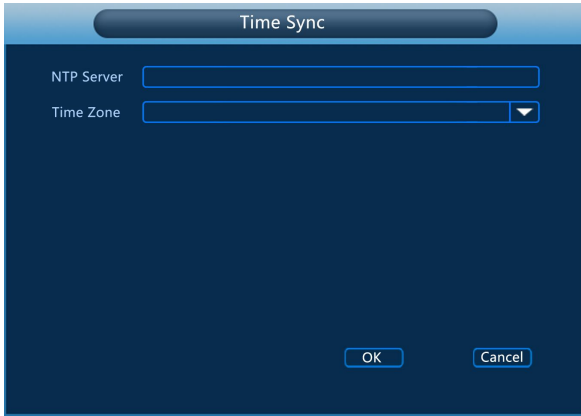

Figure 5-10

5.3.3.2 Encoding parameters

Click "Param" icon under "Sys Setup", switch to interface as Figure 5-11 shows. Resolution, Frame Rate, Stream Type, Bit Rate, Sub-stream can be set under "Param" Interface.

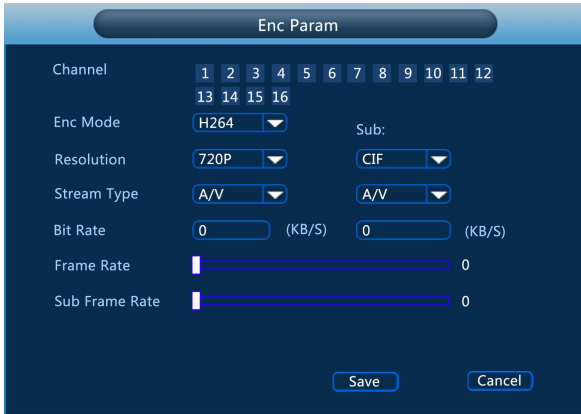

Figure 5-11

- **Channel:** Select the channel number
- **Enc Mode:** Standard H.264.
- **Resolution:** The type of main stream resolution is the encoding parameters of client IPC, generally include D1/720P/1080P etc, the type of sub-stream resolution include D1/VGA/CIF. The resolution is bigger, the better the video quality, and the larger the hard-dish space occupied. On the contrary, the resolution is smaller, the worse the video quality, the smaller the hard-ship space occupied.

- **Stream type:** Select video stream or audio stream..
- **Bit Rate:** Setting bit rate can change the picture quality, the larger the bit rate and the better the picture quality.
- **Frame Rate:** P type: 1 frames / sec-25 frames / sec; N type: 1frames / sec-30frames / sec.
- **Save:** Save the parameters on preview configuration menu.
- **Cancel:** Return to the former interface.

5.3.3.3 Rec Setup

Click "Rec Setup" icon under "Sys Setup", switch to interface as Figure 5-12 shows.

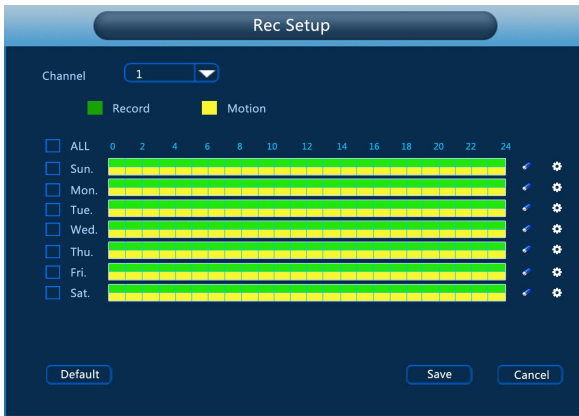



Figure 5-12

- **Channel:** Please select the channel number first. You can select "all" if you want to set for the whole channels.
- **Record Type:** Select check the box to select corresponding record type. There are normal Recording and Motion Detection Recording.
- **Week day:** Set the record schedule, and then the camera automatically starts/stops recording according to the configured Schedule. In the message box, you can choose the day to which you want to set schedule. If you need set schedule every day, choose "all". For the description of the color icon, Green icon stands for normal recording, yellow icon stands for recording triggered by motion.
- : Click it to delete a record type from one period.
- **Default:** Restore parameters of record setup to be default ones.
- **Save:** Save parameters of current interface.
- **Cancel:** Return to the former interface.

Drawing schedule record

Choose the channel and the record type "record" or "motion". Draw the schedule line on the panel of the day you choose. Up to 6 periods can

be configured for each day. And the time periods can't be overlapped each other. See Figure 5-13.

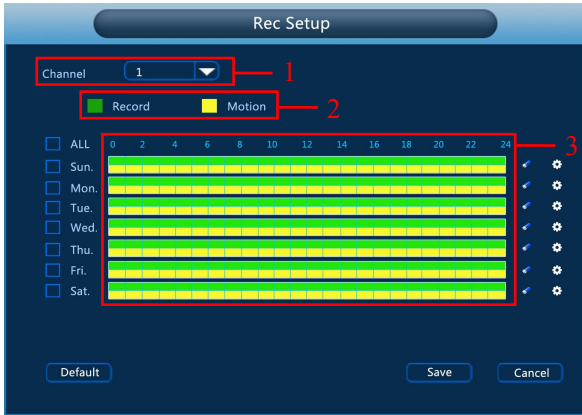

Figure 5-13

Input data to set the schedule record

You can click  button to set the accurate time of the schedule. Choose the record type you wanted and the start time and the end time, Up to 6 periods can be configured for each day. And the time periods can't be overlapped each other. Then can used to which day you wanted to use. See Figure 5-14.



Figure 5-14

5.3.3.4 Network

Click "Network" icon under "Sys Setup", switch to interface as Figure 5-15 shows.

The screenshot shows a network configuration window with the following fields and controls:

- IP:** Input field with a DHCP checkbox to its right.
- Mask:** Input field
- GW:** Input field
- TCP Port:** Input field
- RTSP Port:** Input field
- HTTP Port:** Input field
- DNS:** Input field
- DNS2:** Input field
- Broadcast:** Input field
- MAC:** Input field
- Buttons:** 'Email setup', 'Default', 'Save', 'Refresh', and 'Cancel'.

Figure 5-15

- **DHCP:** After selecting the option, set the access mode of the local IP address to be automatic access, or you should manually set up the IP address.
- **IP Address:** IP address of NVR.
- **Subnet Mask:** Subnet mask of NVR.
- **Default Gateway:** Default gateway of NVR.
- **TCP Port:** Reserved.
- **RTSP Port:** RTSP data port of NVR.
- **HTTP Port:** Port for visit by IE browser for NVR.
- **Primary DNS:** It is usually offered by local ISP. Your IP address of domain name server is entered here.
- **Secondary DNS:** Start secondary DNS when the primary one does not work.
- **Broadcast:** Reserved.
- **MAC:** MAC address of NVR.
- **Default:** Restore all parameters of network setup to be defaulted ones.
- **Save:** Save parameters of common setup interface.
- **Refresh:** clicking Save to save the parameters to the device after finishing all the parameters setup and click Refresh to acquire the latest configuration information of the device.
- **Cancel:** Cancel the set Network of current interface.

Click the Email Setup in the Network Setup to enter the Email Setup interface. When warning information appears in the interface, one can send mails to the designated mail address. The interface is like the following diagram 5-16.

Figure 5-16

- **SMTP server:** the address of the mail server, which can be an IP address and a domain name (domain name needs the confirmation of the correct DNS setup to be resolved correctly).
- **Port:** port number of the mail server.
- **Email Enable:** enabling the mail sending function.
- **Anonymity:** port number of the mail server..
- **User:** user name of the sender's mail.
- **Password:** password of the corresponding user name.
- **Receiver:** the warning information can be sent to the designated receiver via mail.
- **Sender:** setting the EMAIL address of the mail sender.
- **Theme:** the theme of the mail can be set by yourself.
- **File:** when motion detection cooperation is enabled, picture file would be uploaded at the same time if warning information appears.
- **Encryption Type:** enabling SecureSocketLayer port when logging in the mail server.
- **Interval:** interval for sending the alarm mail.
- **Default:** setting all the parameters in the Email Setup interface to be default.
- **Save:** saving the parameters in the Email Setup interface.
- **Cancel:** going back to the former management interface.

5.3.3.5 Motion Detection

Click "Motion Detect" icon under "Sys Setup", switch to interface as Figure 5-17 shows. When the system detects a mobile signal reaches a preset sensitivity occurs, motion detection alarm and the linkage function will be initiated by analyzing the video image.

Figure 5-17

- **Channel No:** Select the motion detection channel. 2 option: Single and All), for the Single channel, you need to choose the particular channel.
- **Switch Link:** Select the check box, turn on the motion detection function.
- **Sensitivity:** Six values can be set for the sensitivity.
- **Area Set:** The video is blocked by the detection area, and an alarm according to the configuration
- **Buzzer on:** Select the check box, The system will trigger the buzzer alarm when motion detect.
- **Buzzer time:** Set the buzzer alarm duration.
- **Record channel:** Select the check box, Select the wanted video channel, and the system will trigger the video signal of the selected channel.
- **Record time:** Set the trigger recording duration.
- **Default:** Recover all the alarm setting parameters to the default values.
- **Save:** Save the set parameters of current menu.
- **Cancel:** Don't save the set parameters of current menu.

5.3.3.6 PTZ Setup

In the preview screen, select a channel preview window, click the right mouse button and click PTZ control options, the preview screen will switch to the single-channel display, and PTZ control interface appears in the lower left corner, as shown in Figure 5-18.



Figure 5-18

Adjusts the movement speed of the PTZ, (click middle button of the wheel to set speed) Directional Buttons controls the movements and directions of the PTZ. zoom, focus, iris can be adjust by increase "+", reducing the "-" button.

- **Presets position:** Can select certain Presets to Configure Preset or Call Preset, range from 1 - 255.
- **Presets point:** The presets box choose a certain preset point need go to, After click on the swith icon, PTZ will jump to that location. Click the Presets button, like pop-up screen shown in Figure 5-19, you can view the setting status of presets from 1-255;

No.	Name	Set	Call	Del	Set or no
2	Preset2			×	NO
3	Preset3			×	NO
4	Preset4			×	NO
5	Preset5			×	NO
6	Preset6			×	NO
7	Preset7			×	NO

Figure 5-19

- **Cruise Settings:** Set the function of cruise, and related presets setting of cruise, including dwelling time and cruising speed. Shown in Figure 5-20 and Figure 5-21;



Figure 5-20

- **Stay Time:** Stay time on the Preset.

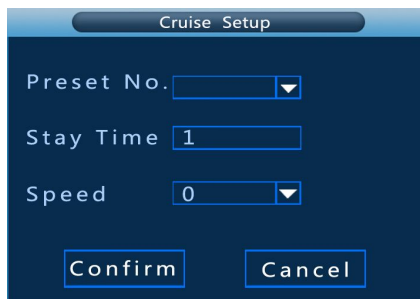

Figure 5-21

- **Cruise speed:** Speed for Cruise.
- **Start Cruise:** Start Cruise, and patrol in fixed path.
- **Auto Scan:** Clear all preset point.

Notice: the NVR supports maximum 255 preset point, however, it is also affected by the PTZ Camera itself, for different PTZ Camera, the number of preset point supported could vary a lot.

5.3.3.7 Display

Click "Display" icon under "Sys Setup", pop up the display configuration interface, could modify the display resolution and channel names, shown in Figure 5-22.

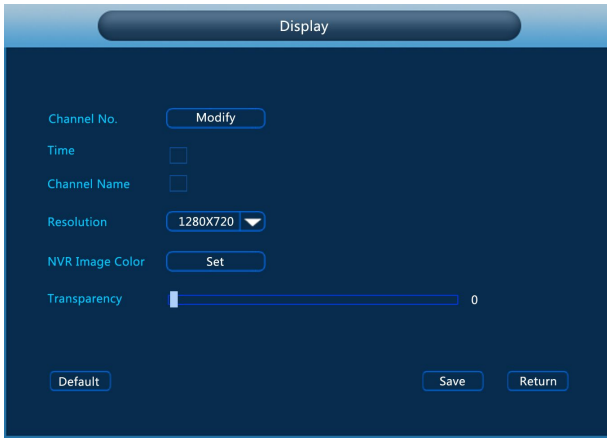

Figure 5-22

- **Time Title/channel title:** After selected  , the displayed time title/channel name can be removed.
- **Resolution:** It means the resolution of video output of NVR. Optional resolution: 1024×768 、 1280×720 、 1280×1024 、 1920×1080. Default resolution is 1280×720. It will be valid only after NVR is re-started with all specifications saved.
- **NVR Image Color:** Set brightness and contrast and other attributes of the NVR.
- **Transparency:** The higher the percentage, the more transparent device local menu.
- **Channel Name:** Click on the name of the channel can be modified to display the name of each channel,as shown in Figure 5-23.



Figure 5-23

5.3.3.8 Restore Default

Click "Default" icon under "Sys Setup", transfer to the interface of default,as shown in Figure 5-24.

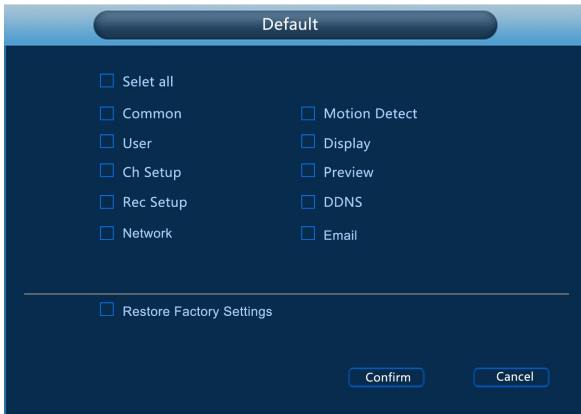

Figure 5-24

According to user selection, you can set the parameters of restore default for "General Settings", "User manage", "Channel configuration", "Record Setup" and "NetWork" and other parameters.

5.3.3.9 Image Color

Click "Image Color" icon under "Sys Setup", pop up the video configuration menu, then can configure the video properties of IPC. As shown in Figure 5-25.

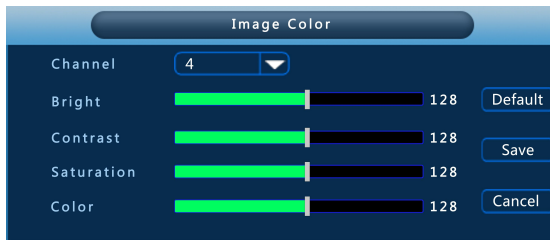

Figure 5-25

- **Channel:** Select the Channel number.
- **Bright:** Bright adjustment.
- **Contrast:** Contrast adjustment.
- **Saturation:** Saturation adjustment.
- **Color:** Color adjustment.
- **Default:** Recover all the video configuration parameters to default value.

- **Save:** Save configured parameters value on video configuration menu.
- **Cancel:** Return to last management menu.

5.3.3.10 DDNS

Click DDNS on the left in the System Setup Menu and the DDNS setup interface will pop up. The NVR can be set up remotely through domain name, which is like the following diagram 5-26.

Figure 5-26

- **DDNS Type:** DDNS Types can be chosen via DDNS. (currently the list supports various DDNS, including ORAY DDNS, 3322 DDNS, TZO DDNS and DYNDNS DDNS. These DDNS can be multiple operated according to users needs and setup.)
- **Enable:** Enabling DDNS domain resolving function.
- **DDNS Refresh Time:** In the searched.
- **User name:** The account registered in the DNS service provider.
- **Password:** The password to the account registered in the DNS service provider.
- **Domain name:** The domain name registered in the DNS service provider.
- **Refresh:** Clicking Save to save the parameters to the device after finishing all the parameters setup and click Refresh to acquire the latest configuration information of the device.
- **Save:** Saving the parameters in the DDNS setup interface.
- **Cancel:** Going back to the former management interface.

When DDNS is successfully configured and enabled, you can type in the registered domain name in the IE address bar directly to link the Web page of the device.

5.3.3.11 P2P Config

Click "P2P Config" icon under "Sys Setup", pop up the P2P Config menu.

P2P is used for remote monitoring of the mobile phone client, by scanning the two-dimensional code can add NVR to the mobile phone client, convenient monitoring. As shown in Figure 5-27.



Figure 5-27

- **Android:** Download Link of P2P client for Android system.
- **ISO:** Download Link of P2P client for Iso system.
- **Save:** Save configured parameters value on video configuration menu.
- **Cancel:** Return to last management menu.



NVR devices support Free Ip and Danale both clients, check to open the platform P2P functionality.

5.3.4 Remote Device

Left-click the "remote device" icon in the main menu, or right-click "menu" in preview interface, move into the remote device management stage, in order to connect devices accordingly, as shown in Figure 5-28.



Figure 5-28

- **search:** Search the IPC devices supported with onvif protocol.
- **Add:** Click , appearing “\” icon means you have selected the IPC device of this column. If the “Device Added” list is not full, click the “Add” and can put this device to the “Device Added” list. Select all searched IPC device, If the “Device Added” list is not full, you can click “Add” after you click “Select All” to add the all the devices to the “Device Added” list.
- **Filter:** Filter the display of the searched device list.
- **Delete:** clicking  in the added devices and clicking Delete, then you can delete the device chosen.
- **Confirm:** Return to last menu.
- **Cancel:** Return to last menu.

Remark: Click on the title bar icon , select all the available IPC device, click again to cancel all selected. Click the  icon can quickly delete the device at the “Device Added” list.

5.3.4.1 Manual Add

Click Manual Add on the left in the Remote Device menu and channels can be set up manually, like diagram 5-29 below.

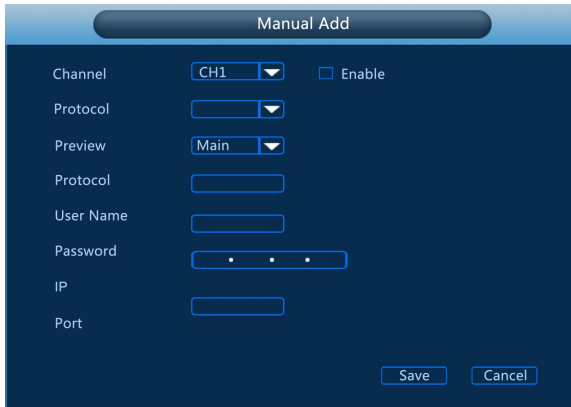

Figure 5-29

- **Channel:** Users can type in the channel number that needs to be connected to the remote device according to their needs.
- **Enable:** The channel enable on/off, defaulting to be off. Tick “Enable” then the related channels can be previewed and recorded normally.
- **Protocol:** Onvif agreement.
- **Preview:** Sub-stream preview is defaulted and IPC port should be dual-stream. Both should be in the format of H264 code to be

previewed normally and the resolution of the sub-stream can be D1 or CIF format.

- **User name:** The login user name of IPC (if the defaulted user name is not admin, please change it to be valid user name).
- **Password:** Login password of IPC (if the defaulted login password is not admin, please change it to be valid password).
- **IP:** IP address of IPC added to NVR.
- **Port:** Defaulting the IPC port to be 8999.
- **Save:** Saving the setup parameters of current channels
- **Cancel:** Going back to the former management interface.

5.3.5 Advance Option

Left-click "Advance Option" in the main menu, as shown below, including disk management, user accounts, equipment upgrades, and configuration of four sub-menu preview 5-30.

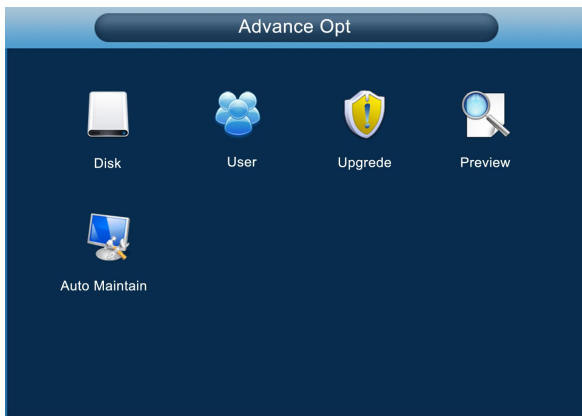

Figure 5-30

5.3.5.1 Disk

Click "Disk" icon under "Advance Option", will switch to the interface of Disk Manage, as shown in Figure 5-31.



Figure 5-31

If the devices have connected the HDD successfully, the HDD manage list will show the information of HDD. You have to format the HDD if the HDD is the first time to connect; If the system detects that do not need to format the hard disk, the HDD status will displays "normal"; If do not connect successfully or could not detect hard disk, will displays the warning "Not connected the HDD".

- **HDD No.:** The number of HDD that connect the system.
 - **State:** Detect the current working status of HDD, you could use only that displays "normal"; After formatting is completed, you need to restart NVR, the status displays "in use".
 - **Total Capacity:** The total available HDD capacity, the single HDD capacity can not exceed the maximum capacity: 4TB.
 - **Residual Capacity:** Display the residual capacity of the current HDD;
 - **Device Type:** SATA.
 - **Refresh:** Refresh HDD information in the list;
 - **Format:** Formatting the HDD, select the HDD that needs to be formatted firstly, and then click the "Format" button, pop-up warning dialog "formatting will result in the selected HDD recording data loss, confirm that you want to continue?", If confirm to format then click on the "OK" button, otherwise click "Cancel".
 - **Cancel:** Return to the former management interface.
- Note:** After formatting the HDD, you need to restart the device.

5.3.5.2 User

Click "User" in "Advance Option" interface, then interface of user management will be out. As followed Figure 5-32 shows.

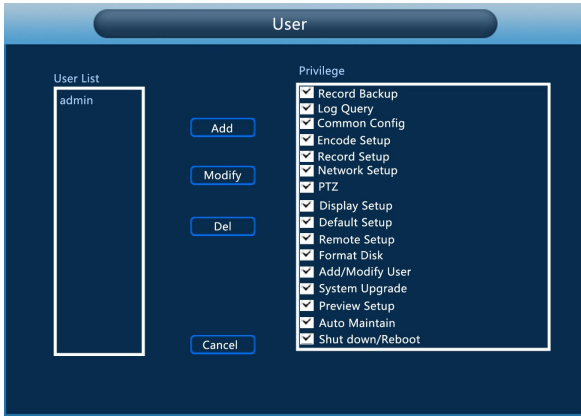

Figure 5-32

- **User List:** List added users. "admin" is super user/administrator, and we cannot change its privilege, but only its password. Other general users have no privilege of adding, modifying or deleting.
- **Privilege:** Privilege list of users. It includes PTZ control, playback, parameter setup, query log, advanced configuration, channel management, query parameter, backup /shut down/ logout.
- **Add:** To add a new user, which can be only done by super administrator--admin. Click "Add", then enter user name and password, select privilege and save the parameters.
- **Modify:** To change information of users, which can be only done by super administrator--admin. First, choose a user, click "modify", then enter old password and new password, modify privilege, and finally save the parameters.
- **Delete:** To delete user, which can be only done by super administrator--admin.
- **Cancel:** Return to former interface.

5.3.5.3 Upgrade

Click "Upgrade" icon under "Advance Option", transfer to the interface of Upgrade Management, As followed Figure 5-33 shows.

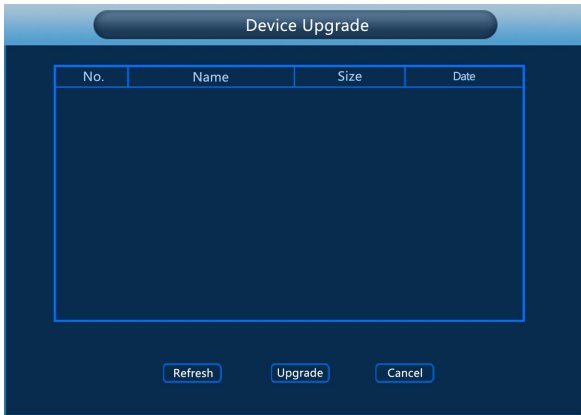

Figure 5-33

If the device have detected upgrade files in the U disk, the related information of upgrade package (number, name, size, date) will be displayed.

U disk Upgrade steps: Copy the upgrade file (named should be the format update_nvr.tgz) to the root directory of U disk, connect this U disk to the device's USB port, if did not display the upgrade file in the list ,please refresh the interface (If the upgrade package still cannot be searched out , please check whether the USB port connect well with the U disk , and also check whether the upgrade file name is correct). After the upgrade file appears, select the upgrade file, click the "upgrading" and begin to upgrade; If you don't want to upgrade, click cancel to return.

Note: During the upgrading process, please do not cut off the power or take off your U disk. After the upgrading, your system will restart automatically. (This process will takes about 3 to 5 minutes.) Here, we advice you to restore factory Settings after the upgrading.

5.3.5.4 Preview

Click "Preview" icon under "Advance Option", transfer to the interface of Preview Configuration, As followed Figure 5-34 shows.



Figure 5-34

- **Boot Preview:** Support image preview of window 1, 4, 6, 8, 9 and 16.
- **Preview Config:** To set channel for preview. To show which window is supported for preview channel.
- **Default:** Restore all parameters of preview config to be default ones.
- **Save:** Save parameters of preview config interface.
- **Cancel:** Back to former interface.

5.3.5.5 Auto Maintain

Click the automatic maintenance icon in the advanced option interface and the automatic maintenance setup interface will pop up, as followed Figure 5-35 shows.

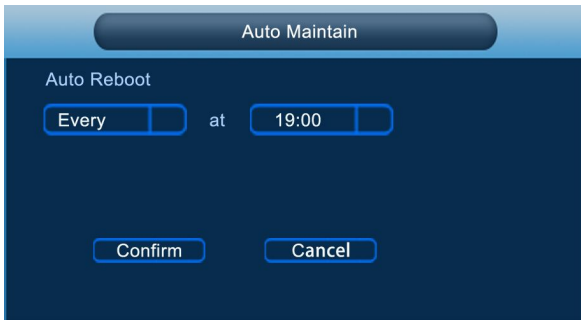

Figure 5-35

User can themselves set the system to be automatically rebooted. Automatically rebooting system can be set in a fixed time periodically. Click OK to save after finishing the setup or click Cancel otherwise.

5.3.6 Shut Down

Click "Shut Down" icon in the main menu, move on to shut down the system interface. Therefore, the system can be canceled, restarted, and shut down, as followed Figure 5-36 shows.

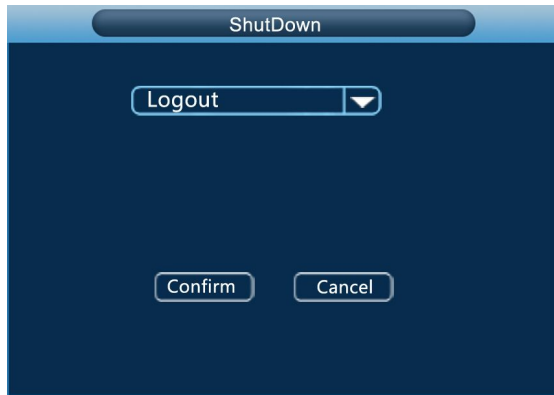

Figure 5-36

- **Logout:** Logout the current user, switch to user login interface.
- **Reboot:** Reboot the device.
- **Shut down:** Shut down the device, just like computer safe shutdown mode.

6 WEB Operation

6.1 Active X install

To make sure NVR connects to Internet successfully, open IE Browser, input required IP address, the default setting is 192.168.1.168, and then the Active X will be downloaded and installed automatically

Notice: 1.For WIN 7, could have problems for backup and recording, if so, please check the Admin setting, procedure as follows:

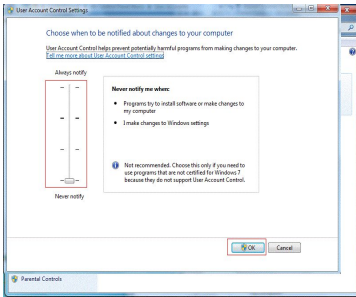

WIN7-1

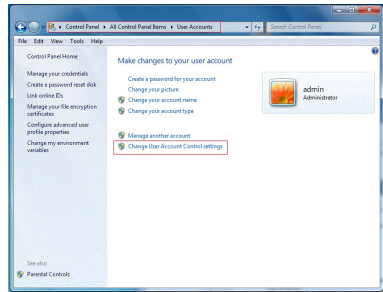

WIN7-2

2.The Active X can't be loaded? Please adjust the security level and firewall setting to the lowest, and make some adjustment to IE as well: Tool-Internet Option- Custom level-ActiveX- enable all the options below ActiveX and click OK! Finally, the Active X will be downloaded and installed automatically, please refer to the Figure 6-1.



Figure 6-1

6.2 IE Login

After the plug-in is installed, login interface as below Figure 6-2, entering the user name and password. The default user name is admin, and the password is 12345, click the login then can remote login.



Figure 6-2

6.3 IE Login Interface

After logging the client successfully, entering live preview interface and video connection automatically. The interface as below Figure 6-3:

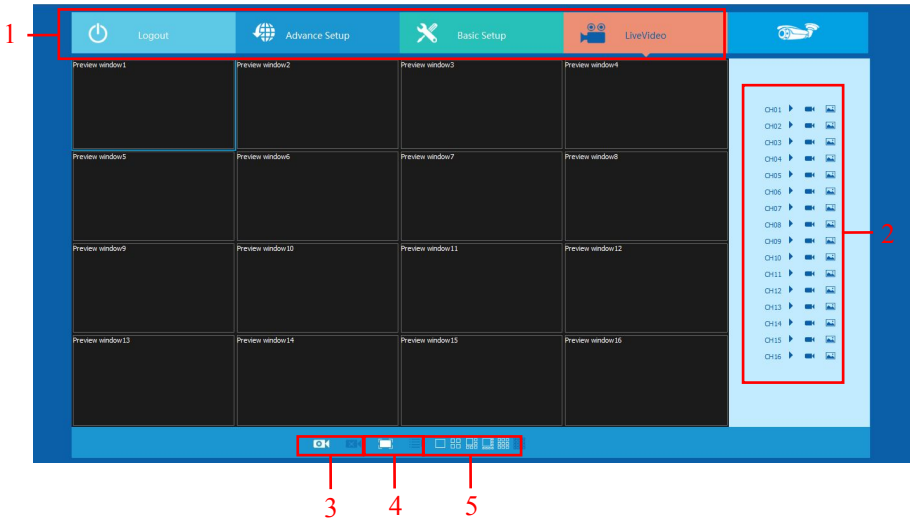







Figure 6-3

1.System Menu. Including Live Video Record Setting, Local Setting and Logout.

2.Real-time Monitoring Channel. Open/Close Preview, Local Video and Photograph.

Mark	Specification
CH1-CH16	Preview Channel.
	Open or close corresponding preview channel.
	Click the button, begin recording, the video saves in computer hard disk.
	Click the button, capture images, the picture saves in computer hard disk.

3.Open/Close All Channels Preview Image

Mark	Specification
	Open all preview channels.
	Close all preview channels.

4.display modes to choose. The left is the preview window in full screen,in this display mode,right-click and select "retreat".

5.Preview Window Switch. from left to right are: Single Channel, Four Channel, Six Channel, Eight Channel, Nine Channel, Sixteen Channel.

6.4 Basic Setup

6.4.1 System

6.4.1.1 Common

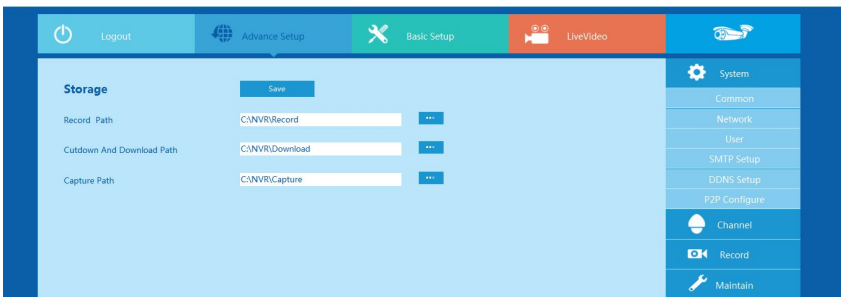

Figure 6-4

Figure 6-4, setting up the current system time of device, date, system language, display resolution and other information.

Parameter	Specification
System Time	Set up the system time of device than saving.
Default language	Set up the device language, you can change the language as you need.
Record Model	Can be set to automatically overwrite when the hard disk is full.
Device ID	Reserved.
Video Standard	The video standard of device must be same with the IPC.
Resolution	HDMI and VGA output resolution of device can be set.
Standby time	Lock time of local time can be set, the time is 1-120 minutes.

6.4.1.2 Network

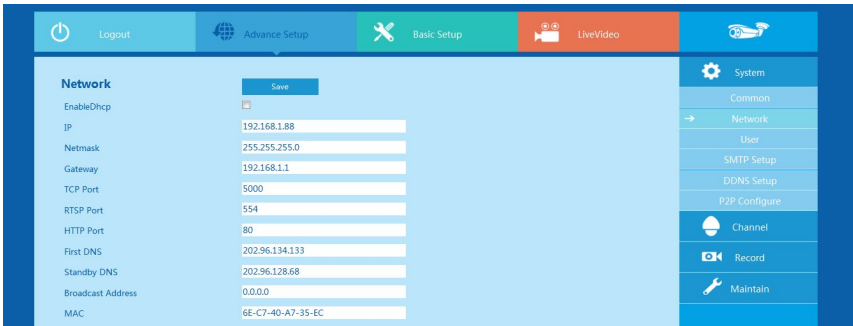

Figure 6-5

Figure 6-5, the IP address, Subnet Mask, Gateway, DNS, TCP port, Data port, HTTP port and related parameters of the device can be set by the interface.

Related parameters setting consistent with NVR client; The IP address effects at once after you modify, don't need restart NVR device.

6.4.1.3 User

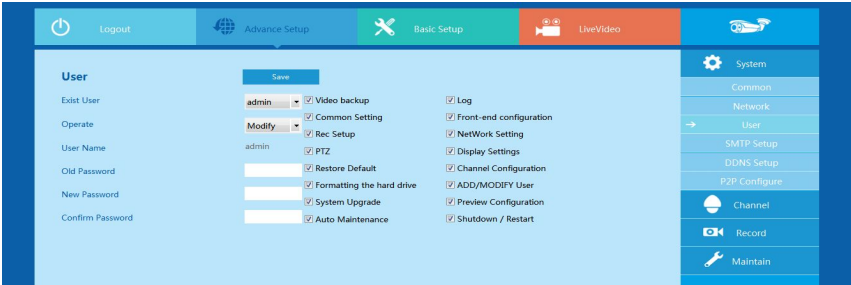

Figure 6-6

Figure 6-6, you can add or delete user, modify the information and rights of user by the interface; Related parameters setting consistent with NVR client.

6.4.1.4 SMTP Setup

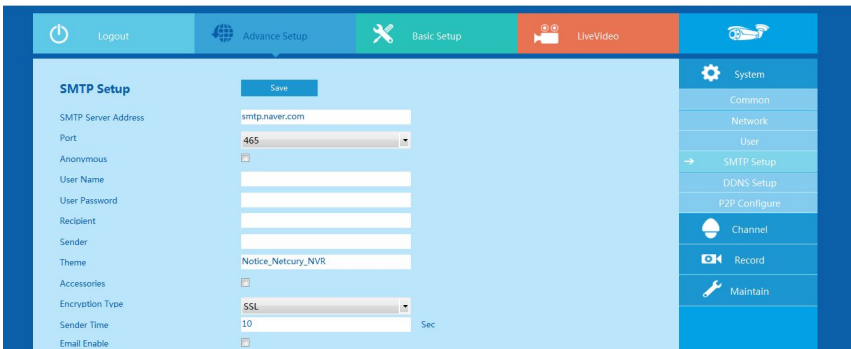

Figure 6-7

Figure 6-7, when alarm message appears, mails can be sent to designated mail address through the setup of this page. The relevant parameters should be set up the same with the NVR port.

6.4.1.5 DDNS Setup

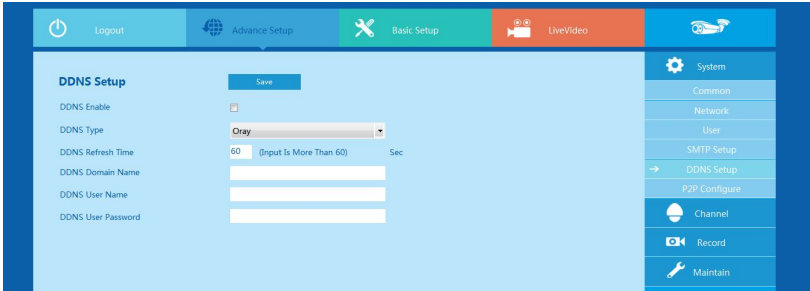

Figure 6-8

Figure 6-8, the NVR can be set up remotely via domain name through this interface and the relevant parameters setup should be the same with the NVR port.

After determining the date in this interface, videos of associated channels can be checked according to the video types. Relevant parameters should be the same with the NVR port.

6.4.1.6 P2P Configure

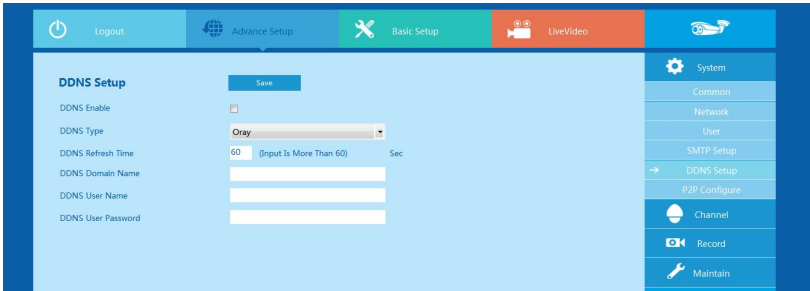

Figure 6-9

Figure 6-9, the P2P function of NVR can be enable in this page, the relevant parameters setup should be the same with the NVR.

6.4.2 Channel

6.4.2.1 Channel Setup

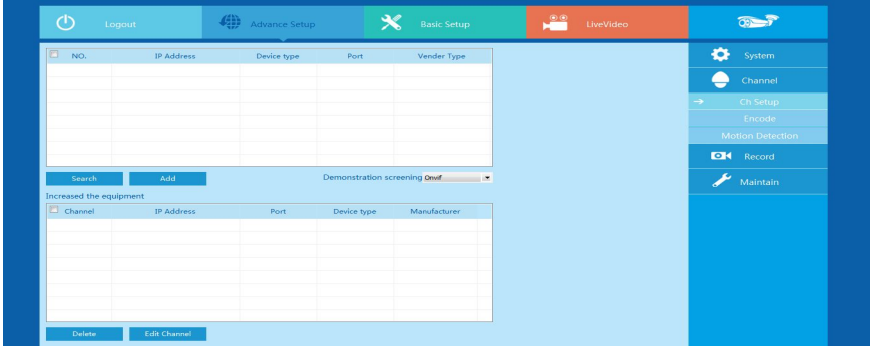

Figure 6-10

Figure 6-10, you can add or modify channel parameters by channel configuration interface; Click "search", you can search IPC device with Onvif protocol with the same network segment with NVR; Selecting the channel number on configuration interface, click the IPC information you search, the channel parameters of the interface will change accordingly, the setting channel parameter settings will become effective after you click the "save".

6.4.2.2 Encode

The interface of encoding parameters as below Figure 6-11, relevant parameters are same with NVR setting.

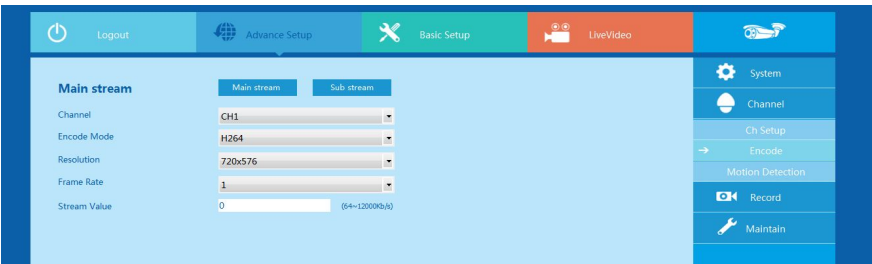

Figure 6-11

You can get parameters of Main-stream and Sub-stream of IPC device of channel access (coding mode, resolution, frame rate, the value of the stream), also can set the value of stream of Main-stream and Sub-stream of IPC device by the interface.

6.4.2.3 Motion Detection

Motion detection interface is shown in Figure 6-12, the relevant parameters consistent with NVR-side settings.

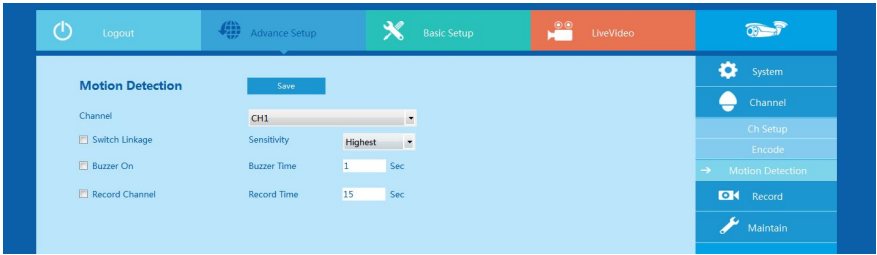

Figure 6-12

The IPC's Main Stream, Sub Stream parameter can be obtained in this page (Coding mode, Resolution, Frame Rate, Stream Value) the Stream Value can be adjusted as well.

6.4.3 Rec Setup

6.4.3.1 Common

Rec Setup interface is shown in Figure 6-13.

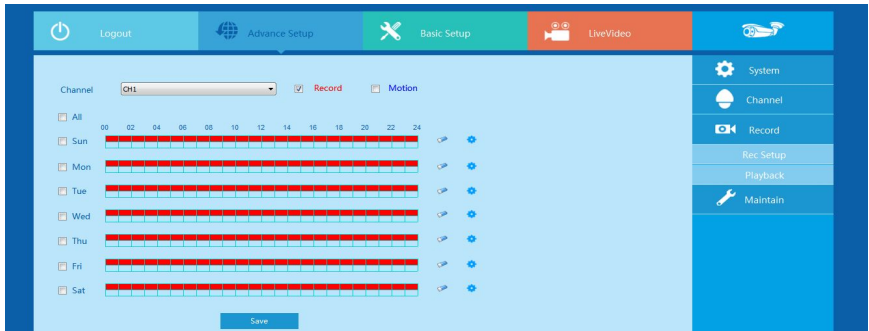

Figure 6-13

You can set up the channel recording as timetable by the interface, relevant parameters are same with NVR setting.

6.4.3.2 Playback

Rec Playback interface is shown in Figure 6-14.

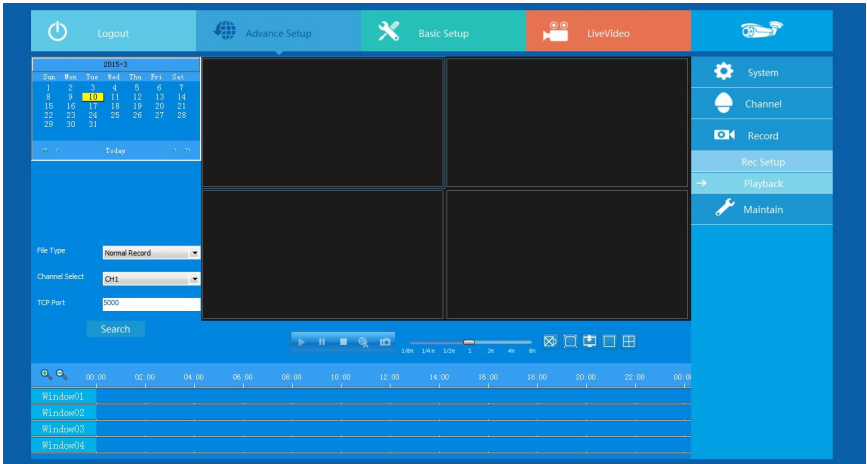

Figure 6-14

After determining the date in this interface, videos of associated channels can be checked according to the video types. Relevant parameters should be the same with the NVR port.

6.5 Advance Setup

Click Advance Setup, than you can find Disk, Device Manage, Default, Log and Version.

6.5.1.1 Disk

You can format the disk (when you use the hard disk to record first time, you need format the disk first), you can find the information of hard disk (Disk Number, State, Total capacity, Residual Capacity and Device Type), as below Figure 6-15.

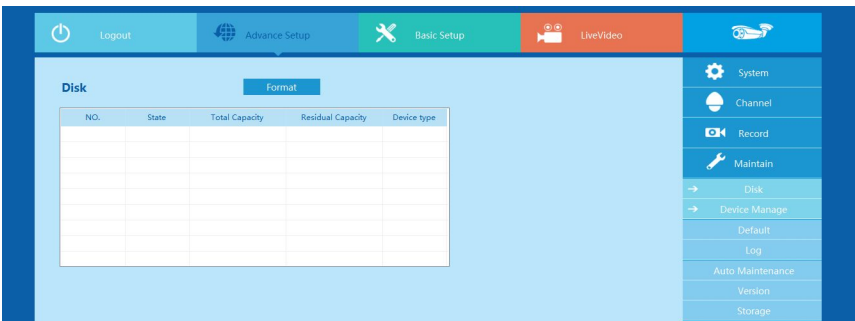

Figure 6-15

6.5.1.2 Device Manage

You can restart and update the device of NVR by remoting, as below Figure 6-16.

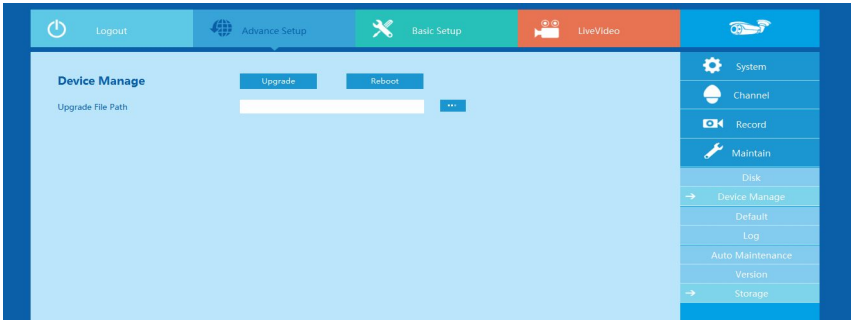

Figure 6-16

6.5.1.3 Default

You can restore the default parameters of NVR by remoting, the method of setting is same with local setting, as below Figure 6-17.

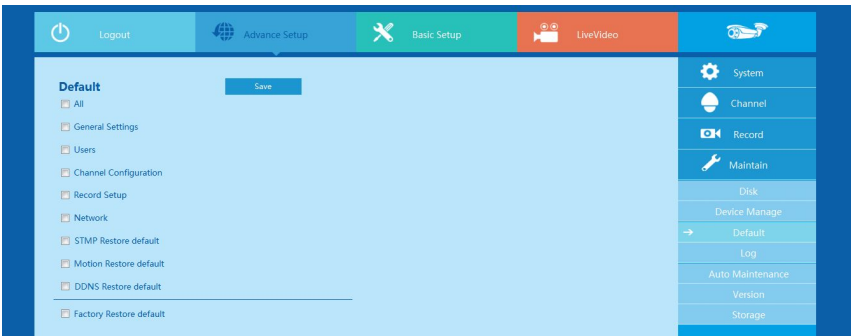

Figure 6-17

6.5.1.4 Log information

You can find specific log information by log query.

Specific steps: Set up the type and time of the journal you need (as below Figure 6-18, you can recall the calendar to choose the date by clicking the blank frame of start time and begin time), click "query" to query the journal, if there has recordings of journal, it will display on list, you can check all journales by page up/page down.

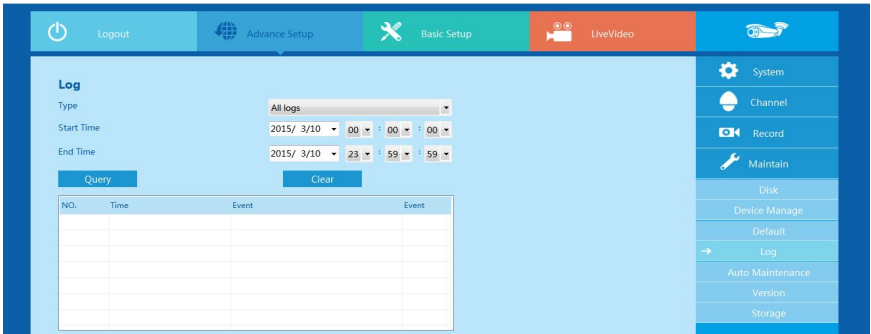

Figure 6-18

6.5.1.5 Auto Maintenance

Here you can set auto-reboot time, You can select proper setup from dropdown list. As below Figure 6-19.

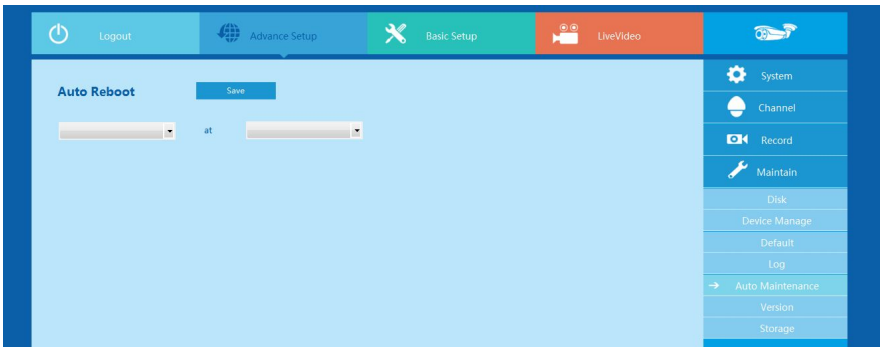

Figure 6-19

6.5.1.6 Version

User can check the version information of the system, including serial number of product, model number, version number and version date. As below Figure 6-20.

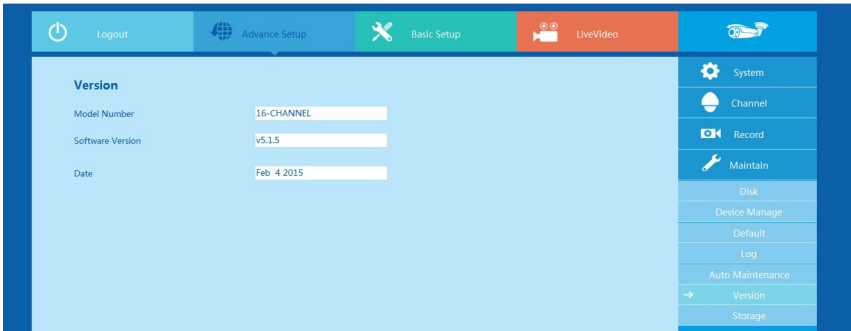

Figure 6-20

6.5.1.7 Storage

In Storage configuration, the user can set up the save path of video file (preview video file) in computer, remote file download and capture image. as below Figure 6-21.

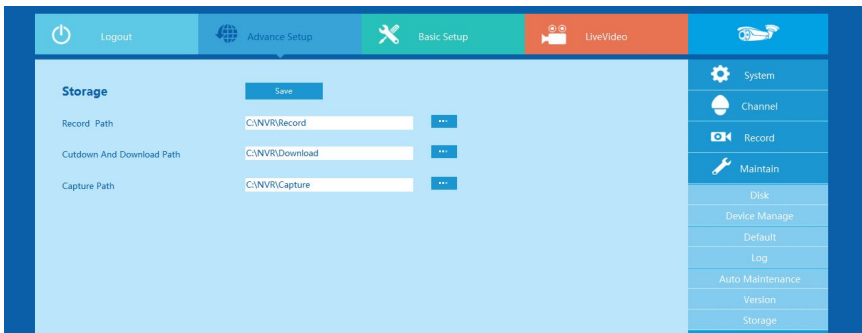

Figure 6-21

6.6 Logout

Click the logout icon , back to the login screen.

7 Appendix

7.1 Q&A

1. How to do when can't detect the hard disk?

Answer: If the system does not detect the hard disk, kindly please check the data line and the power line of hard disk whether are connected well, whether there is a problem about the interface of hard disk on the motherboard, or kindly please check hard disk whether is supported by the NVR in specification.

2. After modifying password, what can you do when you forget the password?

Answer: When the administrator forget password, kindly please get in touch with our technical staff. The easy to remember and relatively safe password is recommended when you set the password (if you have security needs, kindly please don't try to set simple passwords such as 123).

3. what results will maybe happen due to the heat when NVR is working?

Answer: It will produce some heat when NVR is working, kindly please put the NVR in the place where is safe and ventilated to stop the stability and life of the system be affected due to long-term high temperature of NVR.

4. Whether can use if i install the hard disk drive of computer to NVR?

Answer: If the hard disk you use can be supported by the system of NVR, it can work, but you need note, if the NVR begins to work, all datas in your hard disk will loss.

5. Whether can playback when recording?

Answer: Yes.

6. Whether can remove a part of video recordings of hard disk of NVR?

Answer: Considering the security of document, you can't remove a part of video recording, if you need remove all video recordings, you can format the hard disk.

7. Why can't login to NVR client?

Answer: Kindly please check configuration of network connection whether is right, connection of RJ-45 interface whether is fine, if also can't work, kindly please check whether the user name and password are right.

8. Why can't find any recording information when playback?

Answer: Kindly please check whether the connection of data line of hard disk is good, whether the time of system is changed, whether the query condition that is setted can't save video files. If also have the question after restarting, kindly please check whether the hard disk is damaged.

7.2 Maintenance

1. When DVR shutdowns, kindly please don't turn off the power switch directly, should use the shutdown button of system to avoid data loss or damage of the hard disk.
2. Ensure DVR away from high temperature heat source and place.
3. Remove the dust deposited in the body timing, keep the good ventilation around chassis, it is good for radiating.
4. About the audio/video signal line and RS-485 interfaces, kindly please don't hot swap, or these port will be damaged easily.
5. Check the HDD power cable and data cable of the NVR regularly and look whether they are aging.
6. Avoid the audio/video signal effected by other circuits and devices as much as possible, prevent the hard disk damaged by electrostatic or induced voltage.